



# Azərbaycan Respublikası Əqli Mülkiyyət Agentliyi

Patent və Əmtəə Nişanlarının  
Ekspertizası Mərkəzi

RƏSMİ  
BÜLLETEN

ОФИЦИАЛЬНЫЙ  
БЮЛЛЕТЕНЬ

1996-cı ildən  
nəşr edilir

Издается с  
1996 года

Dərc olunma  
tarixi:  
28.02.2019

Дата  
публикации:  
28.02.2019

Şəhadətnamə  
№ 350

# SƏNAYE MÜLKİYYƏTİ

Əmtəə nişanları  
Sənaye nümunələri  
Coğrafi göstəricilər

(aylıq rəsmi bülleten)

# ПРОМЫШЛЕННАЯ СОБСТВЕННОСТЬ

(официальный ежемесячный бюллетень)

Товарные знаки  
Промышленные  
образцы  
Географические  
указания

№ 2  
Bakı - 2019

# Azərbaycan Respublikası Əqli Mülkiyyət Agentliyi

## Patent və Əmtəə Nişanlarının Ekspertizası Mərkəzi

### Redaksiya heyəti

**Kamran İmanov**

**Redaksiya heyətinin sədri,**  
Azərbaycan Respublikası Əqli Mülkiyyət Agentliyinin  
İdarə Heyətinin sədri

### Redaksiya heyətinin üzvləri

**Xudayət Həsənlı**

**Redaksiya heyətinin sədr müavini,**  
Azərbaycan Respublikası Əqli Mülkiyyət Agentliyinin  
tabeliyində olan Patent və Əmtəə Nişanlarının Ekspertizası  
Mərkəzinin direktoru

**Ramin Hacıyev**

Azərbaycan Respublikası Əqli Mülkiyyət Agentliyinin  
tabeliyində olan Patent və Əmtəə Nişanlarının Ekspertizası  
Mərkəzinin Əmtəə nişanı, sənaye nümunəsi və coğrafi  
göstəricilərin ekspertizası şöbəsinin müdirinin v.i.e.

**Ağarza Əliyev**

**Məsul redaktor,**  
Azərbaycan Respublikası Əqli Mülkiyyət Agentliyinin  
tabeliyində olan Patent və Əmtəə Nişanlarının Ekspertizası  
Mərkəzinin İnformasiya texnologiyaları və dərc şöbəsinin  
müdirinin v.i.e.

**ƏMTƏƏ NİŞANLARINA VƏ SƏNAYE NÜMUNƏLƏRİNƏ AİD BİBLİOQRAFİK  
MƏLUMATLARIN İDENTİFİKASIYASI ÜÇÜN BEYNƏLXALQ RƏQQƏM KODLARI  
(WIPO ST.60 STANDARTI)**

- (11) Beynəlxalq qeydiyyat nömrəsi
  - (15) Beynəlxalq qeydiyyat tarixi
  - (19) Dərc edən idarə və ya təşkilatın kodu və yaxud digər identifikasiya vasitəsi
  - (21) İddia sənədinin qeydiyyat nömrəsi
  - (22) İddia sənədinin verilmə tarixi
  - (23) Sərgi ilkinliyi tarixi
  - (28) Beynəlxalq qeydiyyata daxil olan sənaye nümunələrinin miqdarı
  - (31) İlkin iddia sənədinin nömrəsi
  - (32) İlkinlik tarixi
  - (33) İlkinlik ölkəsinin kodu
  - (44) İddia sənədinin dərc edilmə tarixi
  - (45) Beynəlxalq qeydiyyata alınmış sənaye nümunəsinin dərc edilmə tarixi
  - (46) Sənaye nümunəsinin mühüm əlamətlərinin siyahısının dərc edilmə tarixi
  - (51) Sənaye nümunələrinin beynəlxalq təsnifatının (SNBT) indeks(lər)i
  - (54) Sənaye nümunəsinin adı
  - (57) Sənaye nümunəsinin mühüm əlamətlərinin siyahısı
  - (71) İddiaçı(lar), onun (onların) yaşayış yeri və ya olduğu yer barəsində məlumat
  - (72) Müəllif (lər), onun (onların) yaşayış yeri barəsində
  - (73) Patent sahib(lər)i, onun (onların) yaşayış yeri və ya olduğu yer barəsində məlumat
  - (74) Patent müvəkkili və ya nümayəndə barəsində iddia sənədində göstərilibse, onun haqqında məlumat və yaşadığı yer
  - (82) Sənaye nümunəsinin beynəlxalq qeydiyyatında olan iddia edilmiş məlumat
- 
- (111) Qeydiyyat nömrəsi
  - (151) Qeydiyyat tarixi
  - (181) Qeydiyyat müddətinin bitdiyi vaxt
  - (210) İddia sənədinin nömrəsi
  - (220) İddia sənədinin daxil olduğu tarix
  - (230) Sərgi haqqında məlumat
  - (310) İlk iddia sənədinə verilmiş nömrə
  - (330) ÜƏMT 3-cü maddəsinin standartına müvafiq birinci ərizə sənədinin verildiyi ölkənin və ya beynəlxalq təşkilatın kodu
  - (511) Nişanın qeydiyyatı üçün əmtəələrin və xidmətlərin Beynəlxalq təsnifatına uyğun sinfi (sinifləri), əmtəə və xidmətlərin siyahısı
  - (526) Disklamasiya (əmtəə nişanının mühafizə olunmayan elementləri)
  - (540) Əmtəə nişanının şəkli
  - (551) Kollektiv nişana dair məlumat
  - (554) Həcmi nişan
  - (571) Əmtəə nişanının təsviri
  - (591) Əmtəə nişanının rəngi
  - (731) İddiaçının adı və ünvanı
  - (740) Patent müvəkkili
  - (750) Məktublaşma üçün ünvan

**МЕЖДУНАРОДНЫЕ ЦИФРОВЫЕ КОДЫ ДЛЯ ИДЕНТИФИКАЦИИ  
БИБЛИОГРАФИЧЕСКИХ ДАННЫХ, ОТНОСЯЩИХСЯ К ТОВАРНЫМ ЗНАКАМ  
И ПРОМЫШЛЕННЫМ ОБРАЗЦАМ (СТАНДАРТ WIPO CT.60)**

- (11) Номер международной регистрации
  - (15) Дата международной регистрации
  - (19) Код или другие средства идентификации ведомства или организации, осуществившей публикацию
  - (21) Регистрационный номер заявки
  - (22) Дата подачи заявки
  - (23) Дата выставочного приоритета
  - (28) Количество промышленных образцов, включенных в международную регистрацию
  - (31) Номер приоритетной заявки
  - (32) Номер приоритета
  - (33) Код страны приоритета
  - (44) Дата публикации заявки
  - (45) Дата публикации получившего международную регистрацию промышленного образца
  - (44) Дата публикации перечня существенных признаков промышленного образца
  - (51) Индекс(ы) Международной классификации промышленных образцов (МКПО)
  - (54) Название полезной модели
  - (57) Перечень существенных признаков промышленного образца
  - (71) Сведения о заявителе(ях), его(их) местожительстве или местонахождении
  - (72) Сведения об изобретателе(ях), его(их) местожительстве
  - (73) Сведения о патентовладельце(ах), его(их) местожительстве или местонахождении
  - (74) Сведения о представителе или патентном поверенном, если он указан в заявке, его местожительстве
  - (82) Заявленная информация, содержащаяся в международной регистрации промышленного образца
- 
- (111) Номер регистрации
  - (151) Дата регистрации
  - (181) Дата истечения срока действия регистрации
  - (210) Номер заявки
  - (220) Дата подачи заявки
  - (230) Данные о выставках
  - (310) Номер, присвоенный первой заявке
  - (330) Код страны или международной организации по стандарту ВОИС ст.3, куда была подана первая заявка
  - (511) Индексы Международной классификация товаров и услуг для регистрации знаков (Ниццкая классификация), перечень товаров и услуг
  - (526) Дискламация (неохраняемые элементы товарного знака)
  - (540) Воспроизведение знака
  - (551) Указание на то, что знак является коллективным
  - (554) Объемный знак
  - (571) Описание товарного знака
  - (591) Указание цвета или цветового сочетания
  - (731) Имя и адрес заявителя
  - (740) Патентный поверенный
  - (750) Адрес для переписки



**“Sənaye nümunələrinin beynəlxalq qeydiyyatı haqqında” Haqq müqaviləsinin Cenevrə aktı çərçivəsində Azərbaycan Respublikasında qorunan sənaye nümunələri barədə məlumatlar**

**Сведения о международной регистрации промышленных образцов, охраняемых в Азербайджанской Республике в рамках Женевского акта Гаагского соглашения «О международной регистрации промышленных образцов»**

(11) DM/102 774  
 (15) 31.08.2018  
 (22) 31.08.2018  
 (28) 1  
 (51) 02-04  
 (73) VALENTINO S.P.A. (IT)  
 (72) SASSI Stefano  
 (54) 1. Аyaqqabı / 1. Обувь  
 (45) 21.09.2018

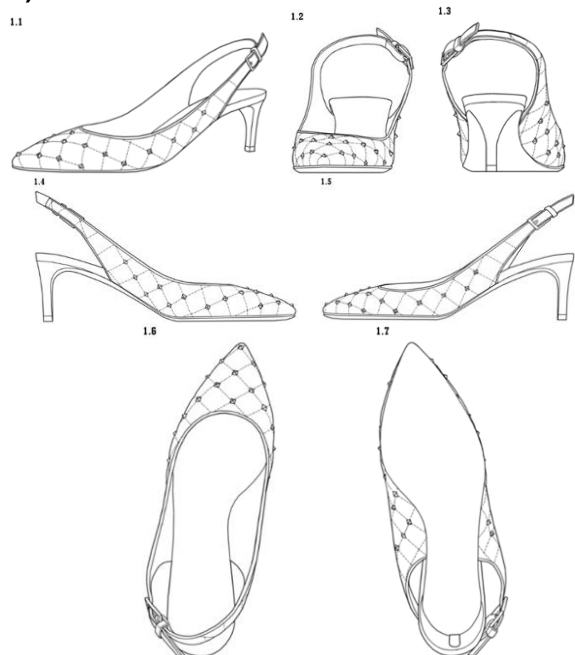

(11) DM/102 775  
 (15) 31.08.2018  
 (22) 31.08.2018  
 (28) 1  
 (51) 03-01  
 (73) VALENTINO S.P.A. (IT)  
 (72) SASSI Stefano  
 (54) 1. Çanta / 1. Сумка  
 (45) 21.09.2018

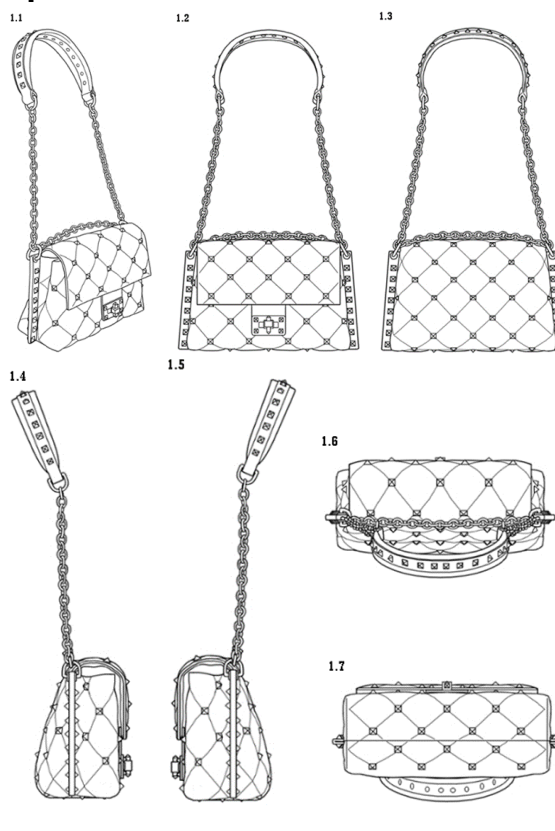

(11) DM/103 284  
 (15) 14.11.2017  
 (22) 14.11.2017  
 (28) 1  
 (51) 03-03  
 (73) MAZY HOLIDAY (US)  
 (72) Mazy Holiday  
 (54) 1. Əl aғасı; / 1.Трость  
 (45) 26.10.2018

**“Sənaye nümunələrinin beynəlxalq qeydiyyatı haqqında” Haqq müqaviləsinin Cenevrə aktı çərçivəsində Azərbaycan Respublikasında qorunan sənaye nümunələri barədə məlumatlar**

Bülleten № 2. 28.02.2019

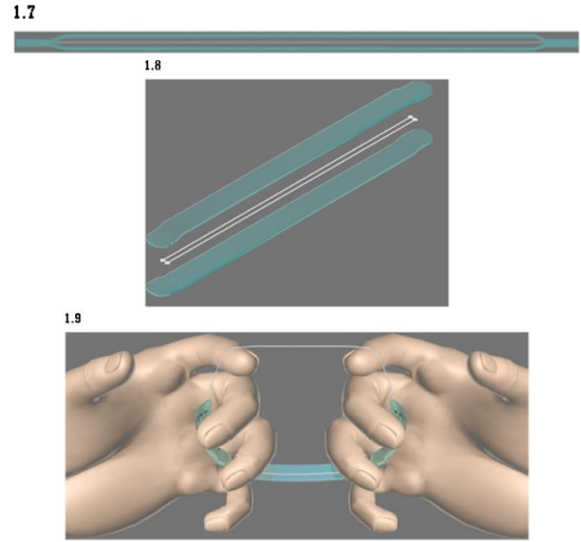
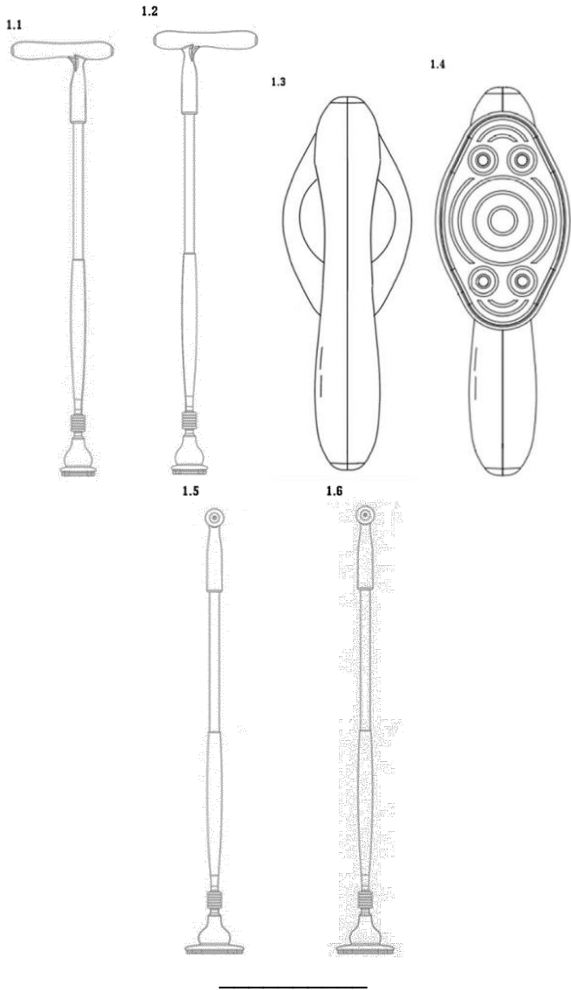

- (11) DM/101 731  
 (15) 21.03.2018  
 (22) 21.03.2018  
 (28) 3  
 (51) 07-01, 02  
 (73) ARÇELİK A.S. (TR)  
 (72) Aslı Ökmen, Nihat Duran, Gizem Durakoglu Emre, Can Onur Vancı, Özlem Kök Gültekin, Tamer Yüksek, Dogaç Can Sağiroşmanoglu, Ece Çınar  
 (54) 1-2. Türk qəhvəsi hazırlayan maşın; 3. Türk qəhvəsi üçün qəhvə qabı / 1-2. Турецкие кофеварки; 3. Кофейник для турецкого кофе  
 (45) 21.09.2018

- (11) DM/101 602  
 (15) 09.05.2018  
 (22) 09.05.2018  
 (28) 1  
 (51) 04-02  
 (73) WOOICK JO (KR)  
 (72) WOOICK JO  
 (54) 1. Dışarısı təmizləyici vasitə / 1. Межзубное очистительное средство  
 (45) 09.11.2018

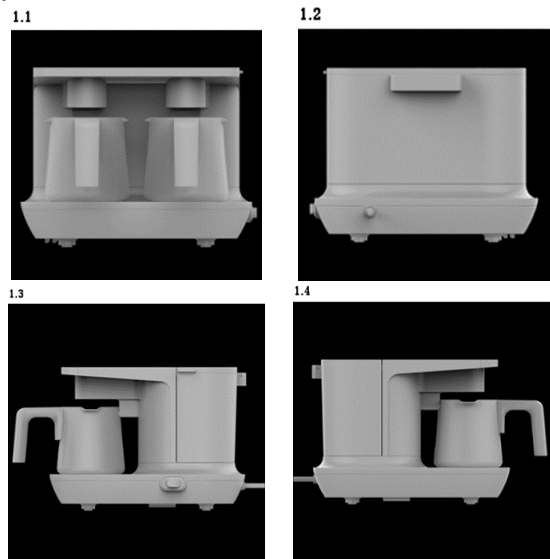
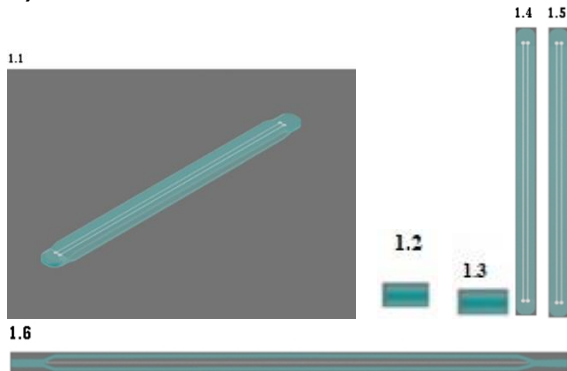

Сведения о международной регистрации промышленных образцов,  
охраняемых в Азербайджанской Республике в рамках Женевского акта  
Гаагского соглашения «О международной регистрации промышленных  
образцов»

Бюллетень № 2. 28.02.2019

1.5



1.6

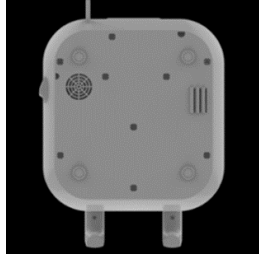

2.7



2.8



1.7

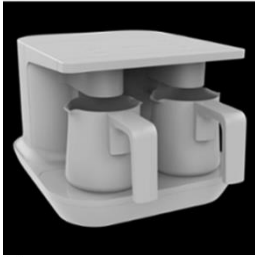

1.8

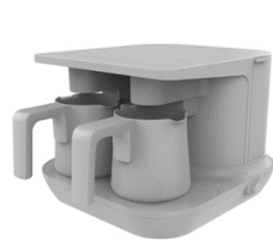

3.1

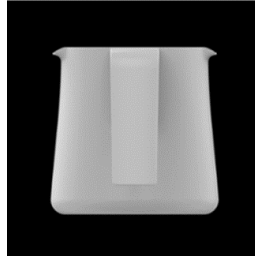

3.2

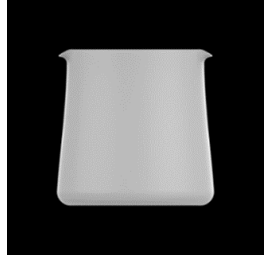

1.9



1.10



3.3

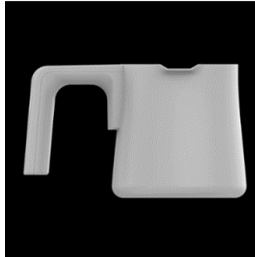

3.4



2.1

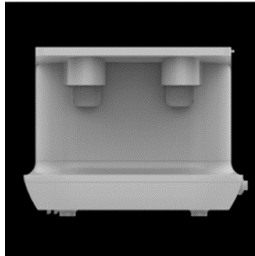

2.2



3.5

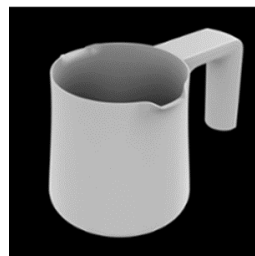

3.6

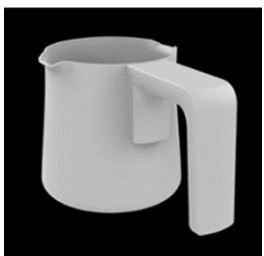

2.3

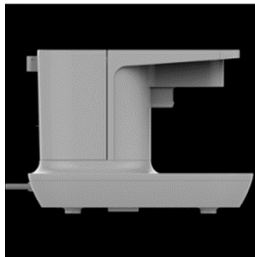

2.4



2.5



2.6

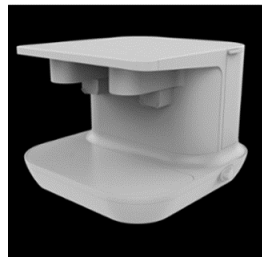

(11) DM/103 683  
(15) 08.08.2018  
(22) 08.08.2018  
(28) 4  
(51) 08-08  
(73) PORTABLE MULTIMEDIA LIMITED (GB)  
(72) Portable Multimedia Limited  
(54) 1-4. Kronşteyn yarışdırıcısı ilə /  
1-4. Кронштейн с присоской  
(45) 23.11.2018

**“Sənaye nümunələrinin beynəlxalq qeydiyyatı haqqında” Haqq müqaviləsinin Cenevrə aktı çərçivəsində Azərbaycan Respublikasında qorunan sənaye nümunələri barədə məlumatlar**

Bülleten № 2. 28.02.2019

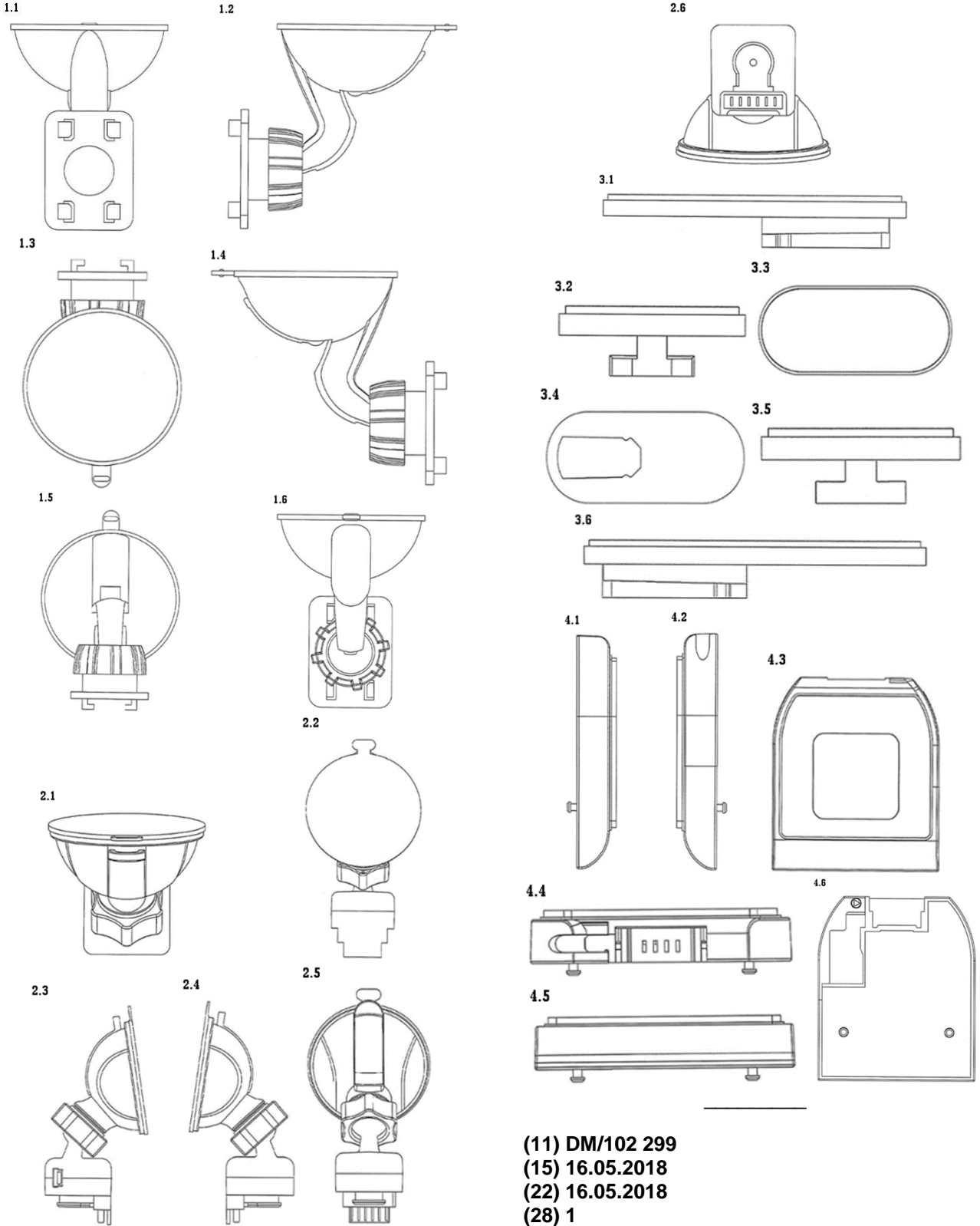

(11) DM/102 299

(15) 16.05.2018

(22) 16.05.2018

(28) 1

(51) 09-01

(73) SIRE SPIRITS, LLC (US)

(72) Curtis J. Jackson

(54) 1. İçki üçün butulka / 1. Бутылка для напитков

(45) 16.11.2018

**Сведения о международной регистрации промышленных образцов,  
охраняемых в Азербайджанской Республике в рамках Женевского акта  
Гаагского соглашения «О международной регистрации промышленных  
образцов»**

Бюллетень № 2. 28.02.2019

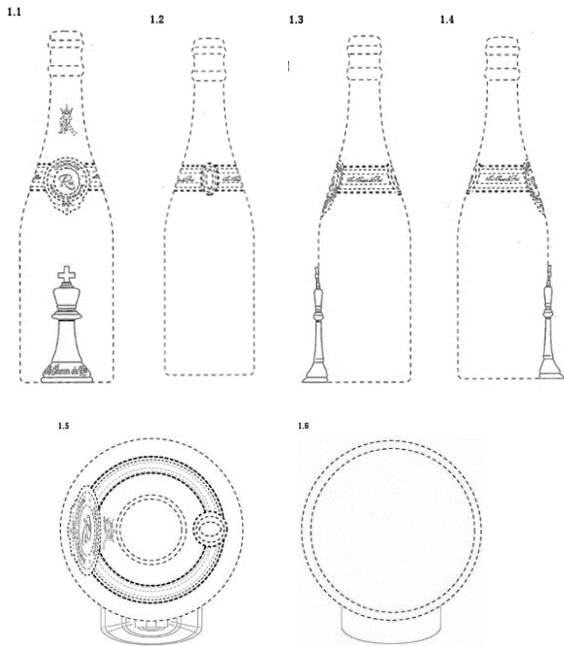

(11) DM/103 030  
(15) 26.09.2018  
(22) 26.09.2018  
(28) 2  
(51) 09-01  
(73) THE ABSOLUT COMPANY AKTIEBOLAG (SE)  
(72) Rowan Miller, Clare Vickers, Ivan Bell, Nick Baker  
(54) 1-2. Butulka / 1-2. Бутылка  
(45) 12.10.2018

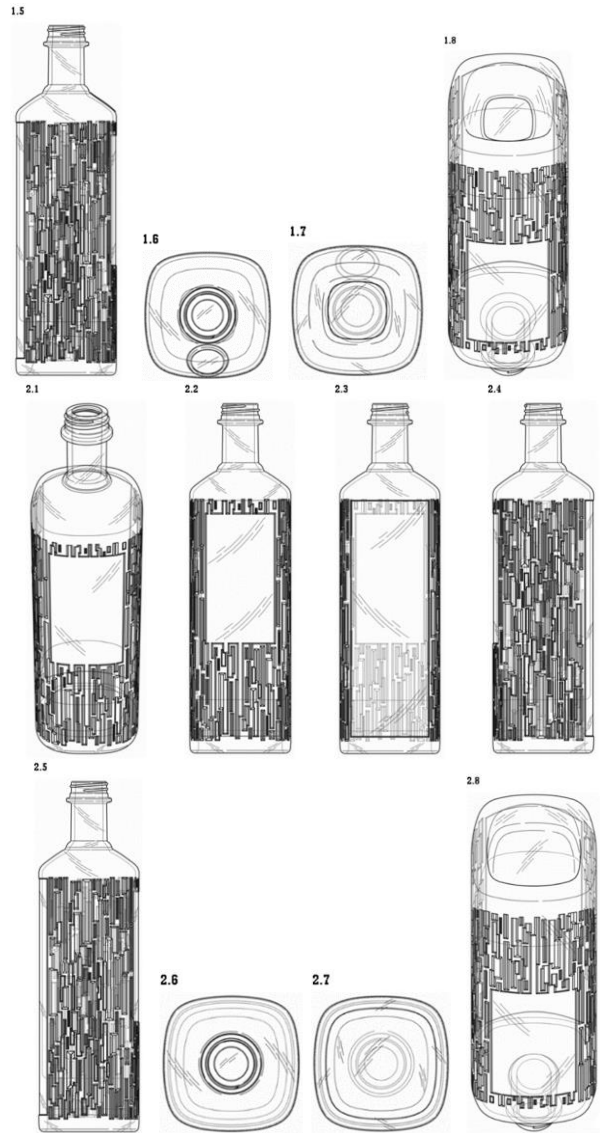
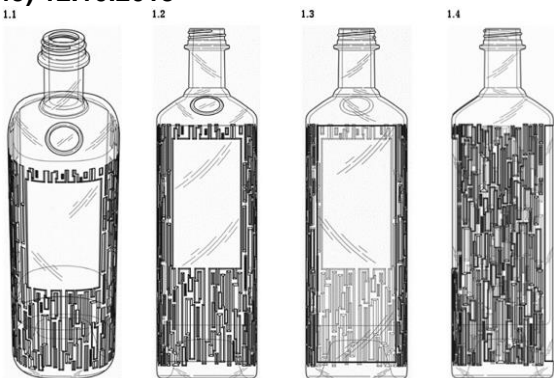

(11) DM/102 820  
(15) 30.08.2018  
(22) 30.08.2018  
(28) 7  
(51) 09-03  
(73) AMADEUS ALS GMBH (AT)  
(72) Sukhyi Sergii Olexandrovych  
(54) 1-7. Qutular [qablaşdırma] / 1-7. Коробки [упаковка]  
(45) 28.09.2018



**“Sənaye nümunələrinin beynəlxalq qeydiyyatı haqqında” Haqq müqaviləsinin Cenevrə aktı çərçivəsində Azərbaycan Respublikasında qorunan sənaye nümunələri barədə məlumatlar**

Bülleten № 2. 28.02.2019

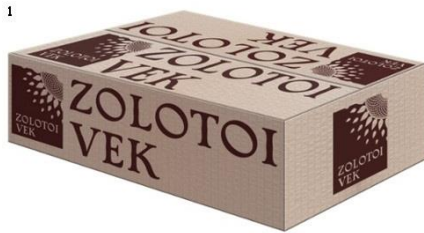

(11) DM/103 590

(15) 22.10.2018

(22) 22.10.2018

(28) 6

(51) 09-03

(73) NOVARTIS AG (CH)

(54) 1-6. Əczaçılıq məmulatı üçün nəzərdə tutulmuş qablaşdırma ornamenti / 1-6.

Орнамент для упаковки для фармацевтических препаратов

(45) 16.11.2018



**Сведения о международной регистрации промышленных образцов, охраняемых в Азербайджанской Республике в рамках Женевского акта Гаагского соглашения «О международной регистрации промышленных образцов»**

Бюллетень № 2. 28.02.2019

4



5



6



- (11) DM/103 684
- (15) 17.05.2018
- (22) 17.05.2018
- (28) 1
- (51) 09-03
- (73) POLARITYTE, INC. (US)
- (72) Denver Lough, Edward Swanson
- (54) 1. Bioloji materialların daşınması və emalı üçün qablaşdırma / 1. Упаковка для транспортировки и обработки биологических материалов
- (45) 23.11.2018

1.1

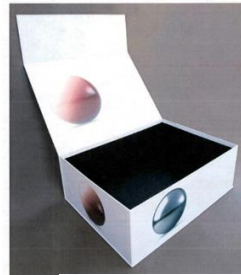

1.2

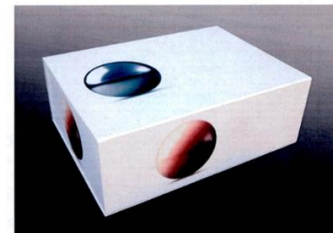

1.3

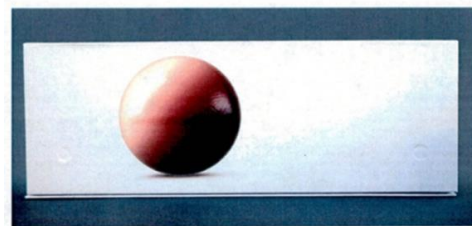

1.4



1.5



1.6

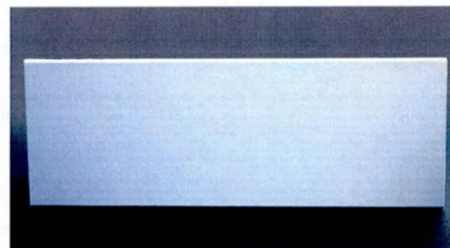

1.7

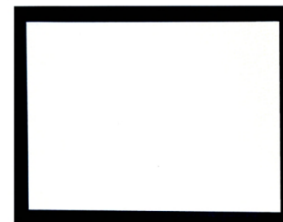

1.8



- (11) DM/100 177
- (15) 02.03.2018
- (22) 02.03.2018
- (28) 1
- (51) 10-01
- (73) HARRY WINSTON SA (CH)
- (72) Emmanuelle DOMINGUEZ
- (54) 1. Zəngli saat / 1. Будильник
- (45) 07.09.2018

1.1

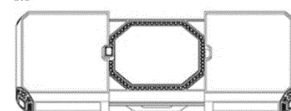

1.2

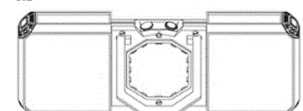

**“Sənayə nümunələrinin beynəlxalq qeydiyyatı haqqında” Haqq müqaviləsinin Cenevrə aktı çərçivəsində Azərbaycan Respublikasında qorunan sənayə nümunələri barədə məlumatlar**

**Bülleten № 2. 28.02.2019**

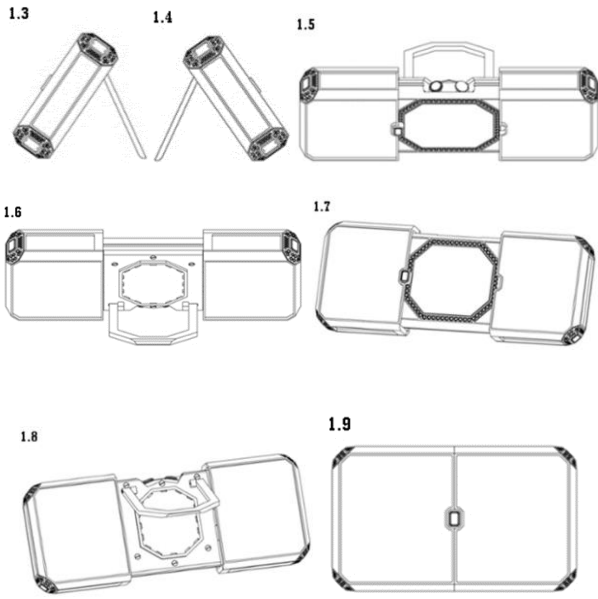

(11) DM/100 181  
 (15) 02.03.2018  
 (22) 02.03.2018  
 (28) 1  
 (51) 10-07  
 (73) BLANCPAIN SA (CH)  
 (72) Fabien HENRIET  
 (54) 1. Siferblat / 1. Циферблат  
 (45) 07.09.2018

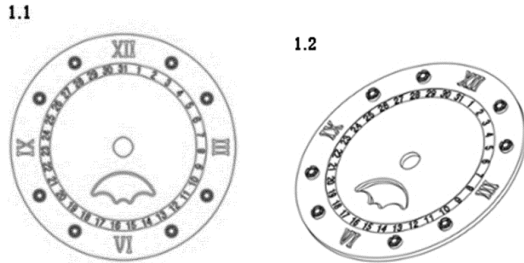

(11) DM/100 183  
 (15) 05.03.2018  
 (22) 05.03.2018  
 (28) 4  
 (51) 10-07  
 (73) OMEGA SA (OMEGA AG) (OMEGA LTD.) (CH)  
 (72) Jean-Claude Monachon  
 (54) 1-2. Siferblatlar; 3. Saat korpusu;  
 4. Siferblat / 1-2. Циферблаты; 3. Корпус часов; 4. Циферблат  
 (45) 07.09.2018

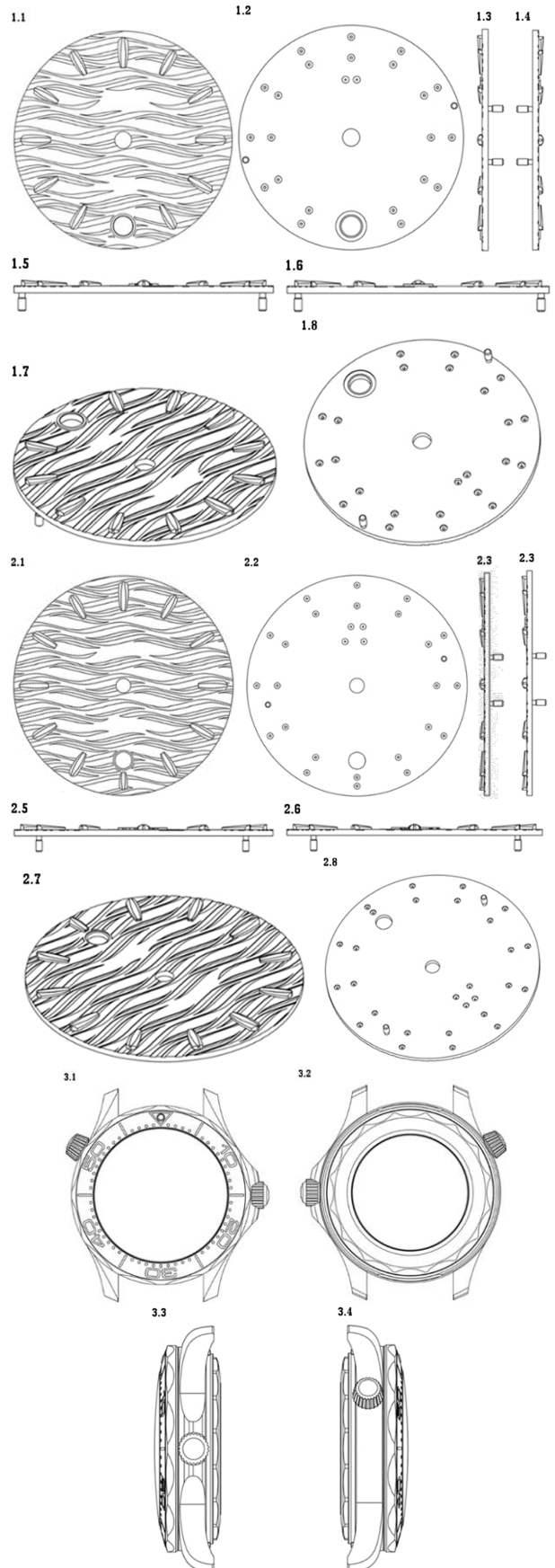



**Сведения о международной регистрации промышленных образцов,  
охраняемых в Азербайджанской Республике в рамках Женевского акта  
Гаагского соглашения «О международной регистрации промышленных  
образцов»**

Бюллетень № 2. 28.02.2019

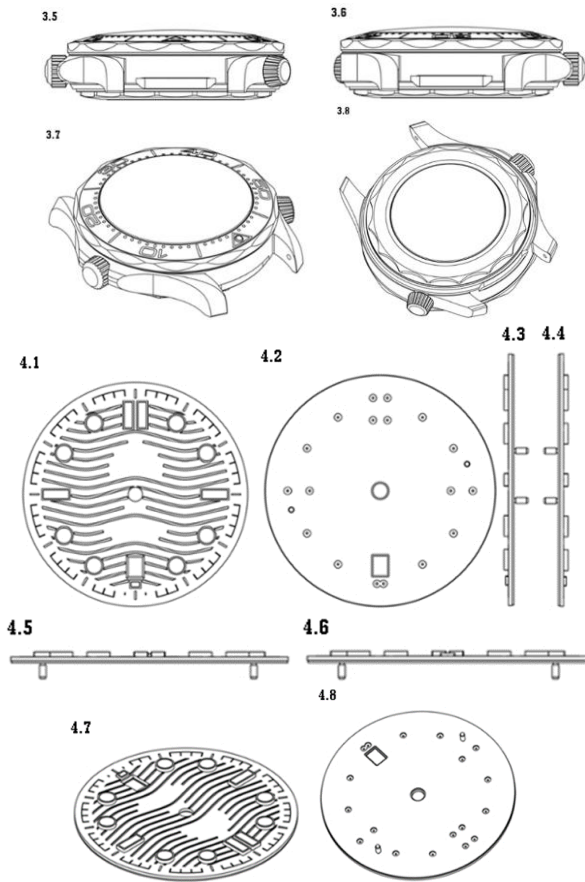

(11) DM/100 185  
 (15) 05.03.2018  
 (22) 05.03.2018  
 (28) 1  
 (51) 10-07  
 (73) MONTRES BREGUET S.A. (CH)  
 (72) Christian CHAUDOT  
 (54) 1. Saatin hərəkətli hissəsi / 1. Движущиеся  
 части часов  
 (45) 07.09.2018

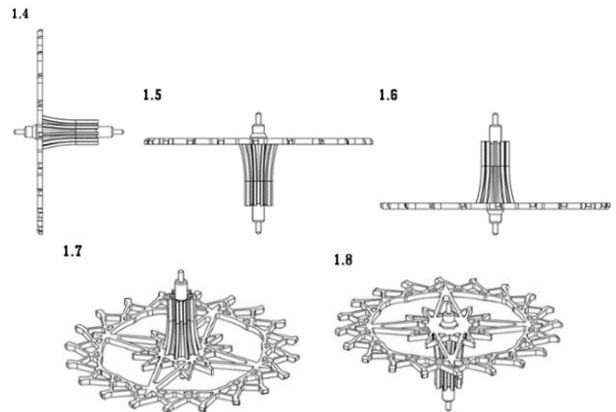
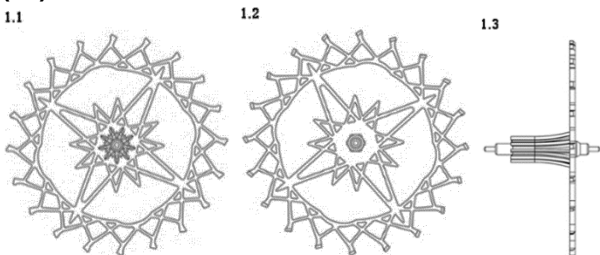

(11) DM/101 418  
 (15) 29.05.2018  
 (22) 29.05.2018  
 (28) 1  
 (51) 10-07  
 (73) OMEGA SA (OMEGA AG) (OMEGA LTD.)  
 (CH)  
 (72) Jean-Claude Monachon  
 (54) 1. Saat bilərziyi / 1. Браслет часов  
 (45) 30.11.2018

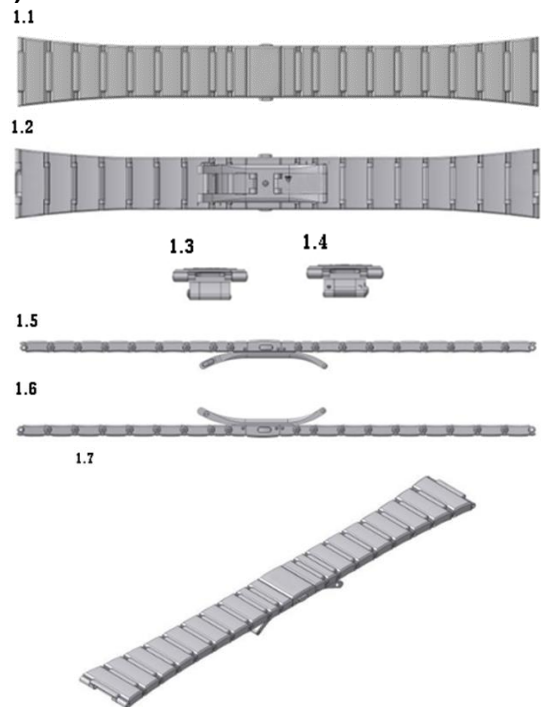

(11) DM/100 318  
 (15) 14.03.2018  
 (22) 14.03.2018  
 (28) 4  
 (51) 10-07  
 (73) MONTRES JAQUET DROZ SA (MONTRES  
 JAQUET DROZ AG) (MONTRES JAQUET

**“Sənaye nümunələrinin beynəlxalq qeydiyyatı haqqında” Haqq müqaviləsinin Cenevrə aktı çərçivəsində Azərbaycan Respublikasında qorunan sənaye nümunələri barədə məlumatlar**

Bülleten № 2. 28.02.2019

**DROZ LTD.) (CH)**

**(72) 1-4. Thanh Le Ngoc, Christian Lattmann**

**(54) 1-2. Saat korpusu; 3. Saat korpusunun hissəsi; 4. Siferblat / 1-2. Корпус часов; 3. Часть корпуса часов; 4. Циферблат**

**(45) 14.09.2018**

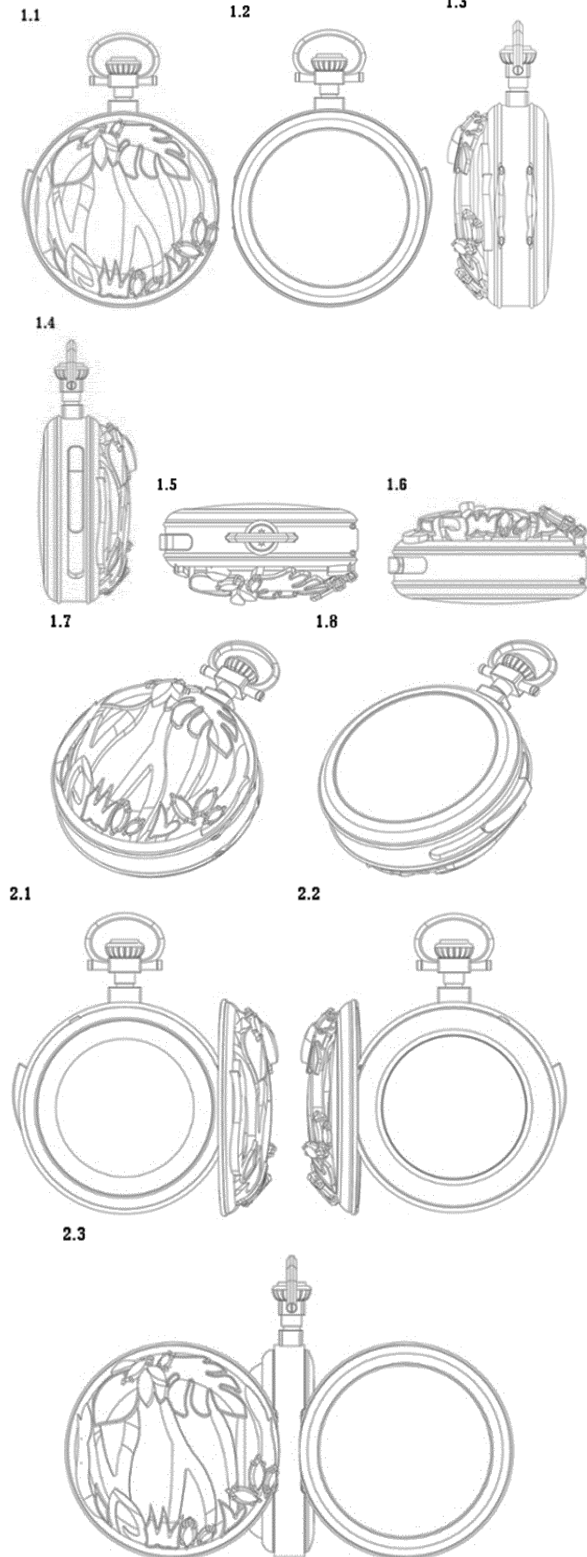

**Сведения о международной регистрации промышленных образцов,  
охраняемых в Азербайджанской Республике в рамках Женевского акта  
Гаагского соглашения «О международной регистрации промышленных  
образцов»**

Бюллетень № 2. 28.02.2019

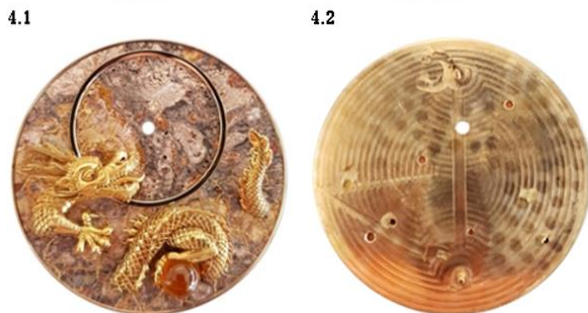
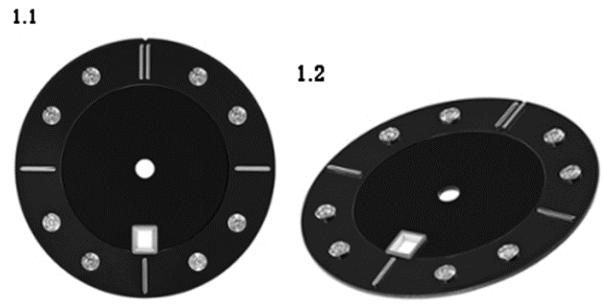

(11) DM/100 888  
(15) 26.04.2018  
(22) 26.04.2018  
(28) 7  
(51) 11-01  
(73) HARRY WINSTON SA (CH)  
(72) Rie YATSUGI-KANG  
(54) 1. Boyunbağı; 2. Üzük; 3. Sırğa;  
4. Boyunbağı; 5. Üzük; 6. Sırğa;  
7. Boyunbağı / 1. Ожерелье; 2. Кольцо;  
3. Серьги; 4. Ожерелье; 5. Кольцо;  
6. Серьги; 7. Ожерелье  
(45) 26.10.2018

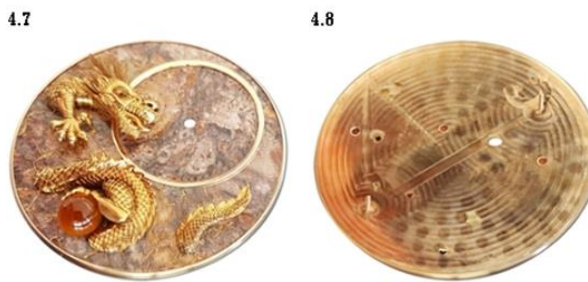
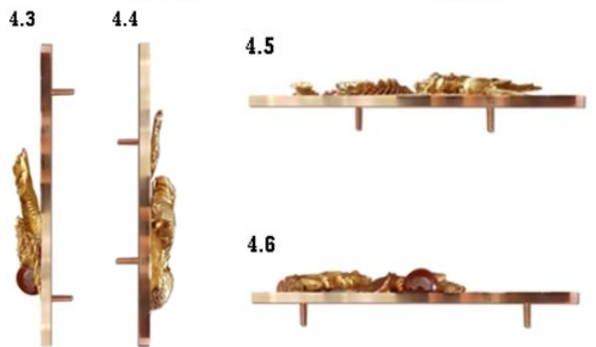

(11) DM/100 325  
(15) 19.03.2018  
(22) 19.03.2018  
(28) 1  
(51) 10-07  
(73) TISSOT SA (TISSOT AG) (TISSOT LTD)  
(CH)  
(72) Fiona MATTHEY, David QUINCHE  
(54) 1. Saat siferblati / 1. Циферблат часов  
(45) 23.11.2018





**“Sənaye nümunələrinin beynəlxalq qeydiyyatı haqqında” Haqa müqaviləsinin Cenevrə aktı çərçivəsində Azərbaycan Respublikasında qorunan sənaye nümunələri barədə məlumatlar**

Bülleten № 2. 28.02.2019



Сведения о международной регистрации промышленных образцов,  
охраняемых в Азербайджанской Республике в рамках Женевского акта  
Гаагского соглашения «О международной регистрации промышленных  
образцов»

Бюллетень № 2. 28.02.2019



**“Sənayə nümunələrinin beynəlxalq qeydiyyatı haqqında” Haaqa müqaviləsinin Cenevrə aktı çərçivəsində Azərbaycan Respublikasında qorunan sənayə nümunələri barədə məlumatlar**

Bülleten № 2. 28.02.2019

7.7



7.8



(11) DM/103 548

(15) 08.08.2018

(22) 08.08.2018

(28) 2

(51) 14-03

(73) PORTABLE MULTIMEDIA LIMITED (GB)

(72) Portable Multimedia Limited

(54) 1-2. Tezlik çeviriciləri [radio və televiziya] /  
1-2. Преобразователи частоты [радио и телевидение]

(45) 16.11.2018

(11) DM/102 155

(15) 03.07.2018

(22) 03.07.2018

(28) 1

(51) 11-02

(73) MONTRES JAQUET DROZ SA (MONTRES JAQUET DROZ AG) (MONTRES JAQUET DROZ LTD.) (CH)

(72) Christian LATTMANN, Yann LEIGGENER

(54) 1. Dekorativ obyekt / 1. Декоративный объект

(45) 21.09.2018

1.1



1.2



1.3



1.4



1.5



1.6



1.7



1.8



1.1

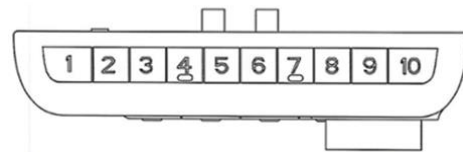

1.2

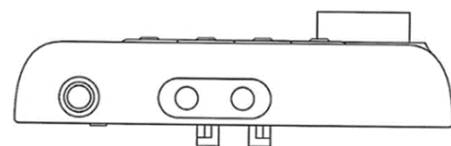

1.3

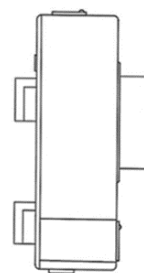

1.5

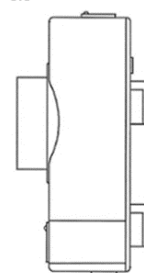

1.4

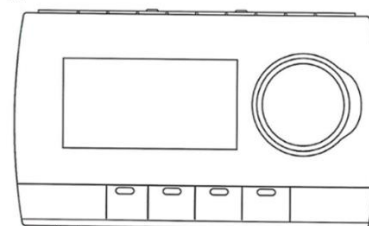

1.6

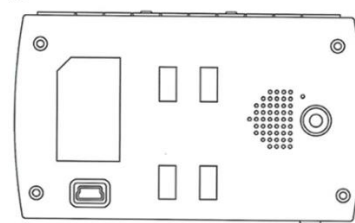

2.1

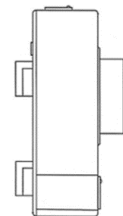

2.2

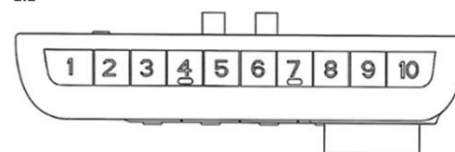

**Сведения о международной регистрации промышленных образцов,  
охраняемых в Азербайджанской Республике в рамках Женевского акта  
Гаагского соглашения «О международной регистрации промышленных  
образцов»**

Бюллетень № 2. 28.02.2019

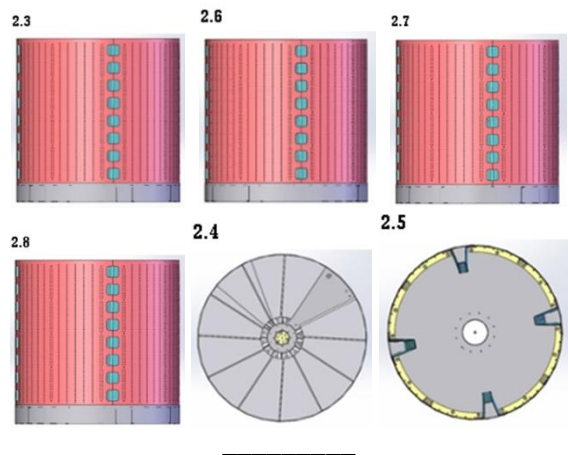
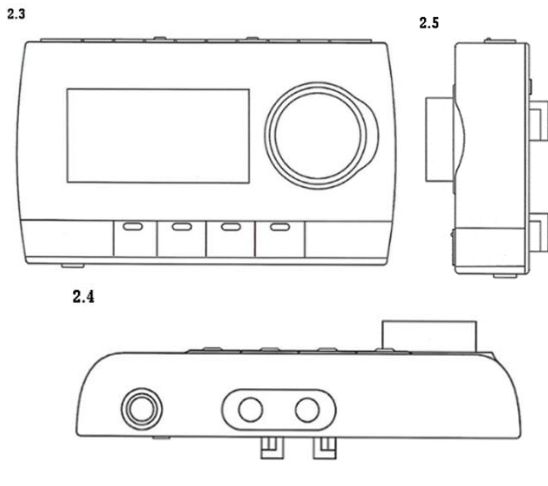

(11) DM/102 492  
(15) 16.08.2018  
(22) 16.08.2018  
(28) 2  
(51) 15-05  
(73) TOLKAR MAKİNA SANAYİ VE TİCARET ANONİM ŞİRKETİ (TR)  
(72) Tolkar Hasan KARACE  
(54) 1-2. Paltaryuyan maşının barabanları / 1-2. Барабаны стиральных машин  
(45) 07.09.2018

(11) DM/101 512  
(15) 08.03.2018  
(22) 08.03.2018  
(28) 1  
(51) 16-06  
(73) CHRISTIAN DIOR COUTURE (FR)  
(72) Mathieu JAMIN  
(54) 1. Eynək / 1. Очки  
(45) 14.09.2018

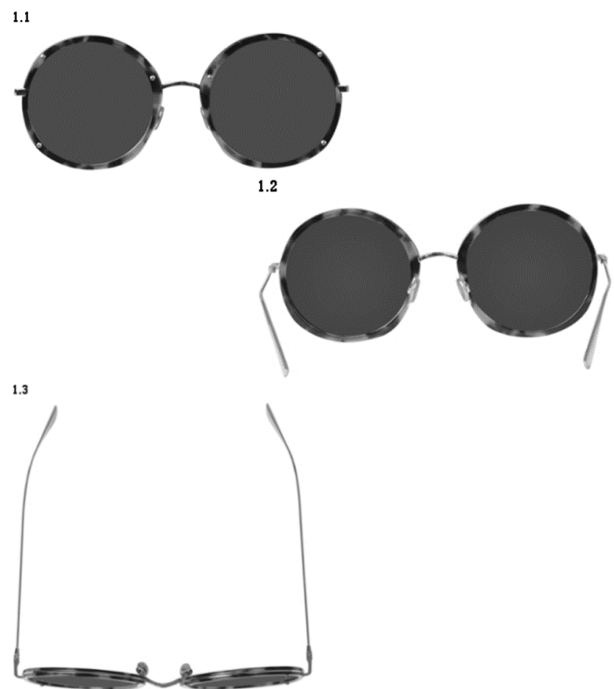
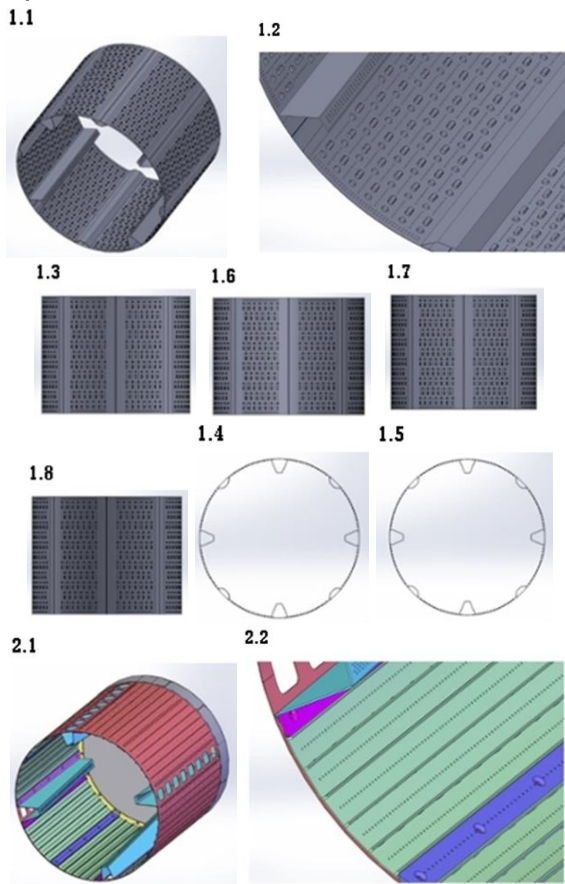



**“Sənaye nümunələrinin beynəlxalq qeydiyyatı haqqında” Haqq müqaviləsinin Cenevrə aktı çərçivəsində Azərbaycan Respublikasında qorunan sənaye nümunələri barədə məlumatlar**

Bülleten № 2. 28.02.2019

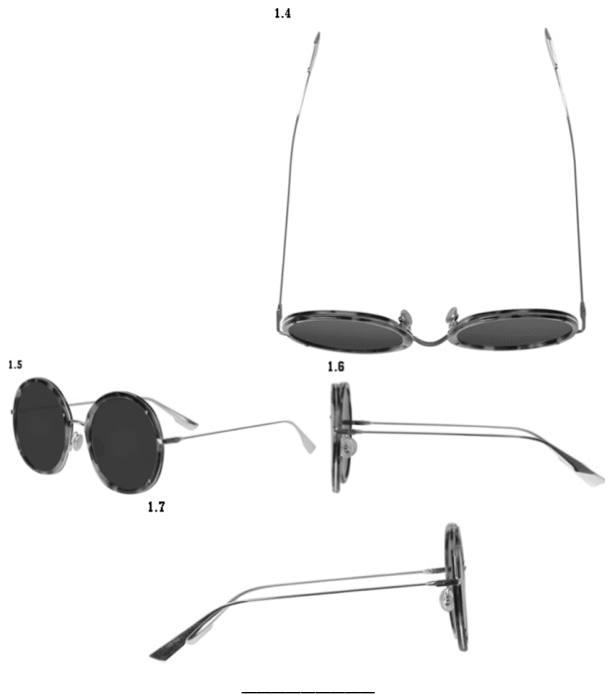

(11) DM/102 443  
(15) 27.03.2018  
(22) 27.03.2018  
(28) 1  
(51) 16-06  
(73) CHRISTIAN DIOR COUTURE (FR)  
(72) Mathieu JAMIN  
(54) 1. Eynək / 1. Очки  
(45) 28.09.2018  
1.1



1.2



1.4



1.3



(11) DM/103 596  
(15) 24.05.2018  
(22) 24.05.2018  
(28) 1  
(51) 16-06  
(73) CHRISTIAN DIOR COUTURE (FR)  
(72) Mathieu JAMIN  
(54) 1. Eynək / 1. Очки  
(45) 23.11.2018  
1.1



1.2



1.3

1.4





**Сведения о международной регистрации промышленных образцов,  
охраняемых в Азербайджанской Республике в рамках Женевского акта  
Гаагского соглашения «О международной регистрации промышленных  
образцов»**

Бюллетень № 2. 28.02.2019

1.5

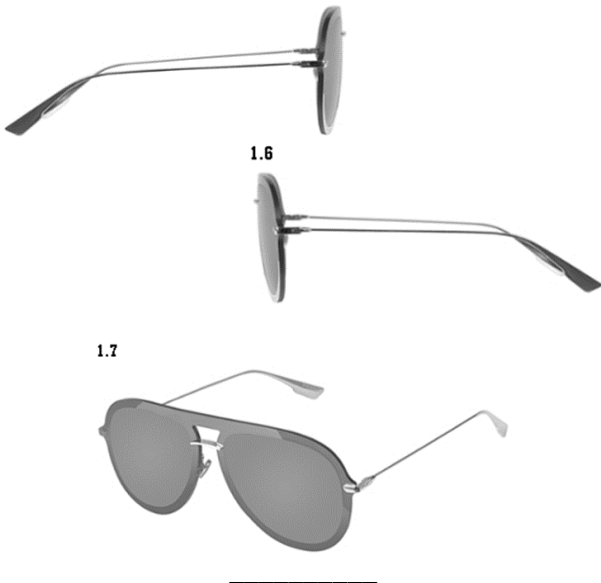

- (11) DM/102 154
- (15) 19.03.2018
- (22) 19.03.2018
- (28) 1
- (51) 17-05
- (73) MONTRES JAQUET DROZ SA (MONTRES  
JAQUET DROZ AG) (MONTRES JAQUET  
DROZ LTD.) (CH)
- (72) Christian LATTMANN, Yann LEIGENER
- (54) 1. Saatın fit salan mexanizmi /  
1. Свистковый механизм часов
- (45) 21.09.2018

1.1



1.2



1.3

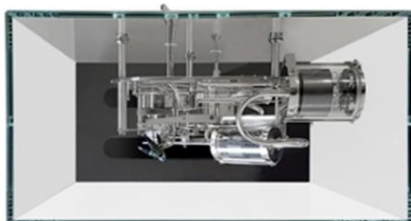

1.4



1.5



1.6

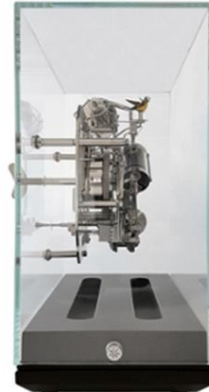

1.7

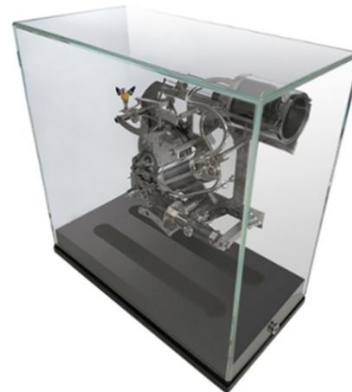

1.8



- (11) DM/100 219
- (15) 02.03.2018
- (22) 02.03.2018
- (28) 1
- (51) 19-06
- (73) HARRY WINSTON SA (CH)
- (72) Coralie BLOOTACKER

**“Sənaye nümunələrinin beynəlxalq qeydiyyatı haqqında” Haqq müqaviləsinin Cenevrə aktı çərçivəsində Azərbaycan Respublikasında qorunan sənaye nümunələri barədə məlumatlar**

Bülleten № 2. 28.02.2019

(54) 1. İmza maşını / 1.Машина для подписи  
(45) 07.09.2018

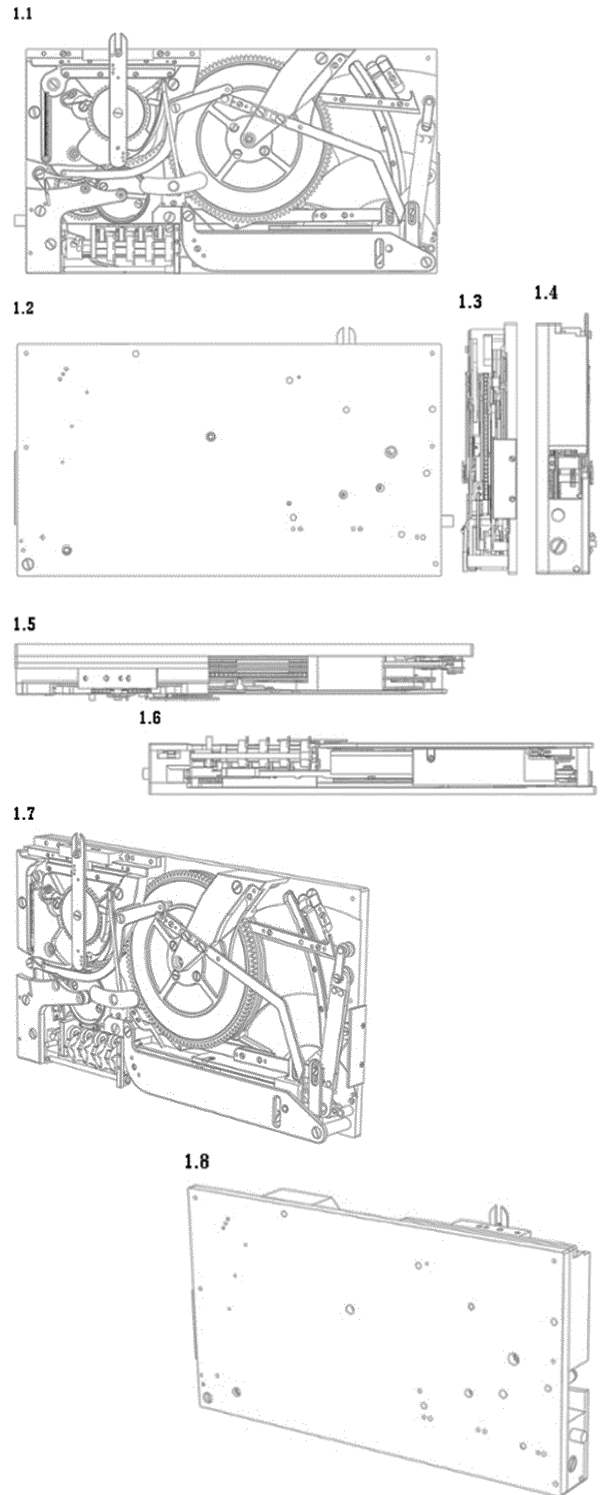
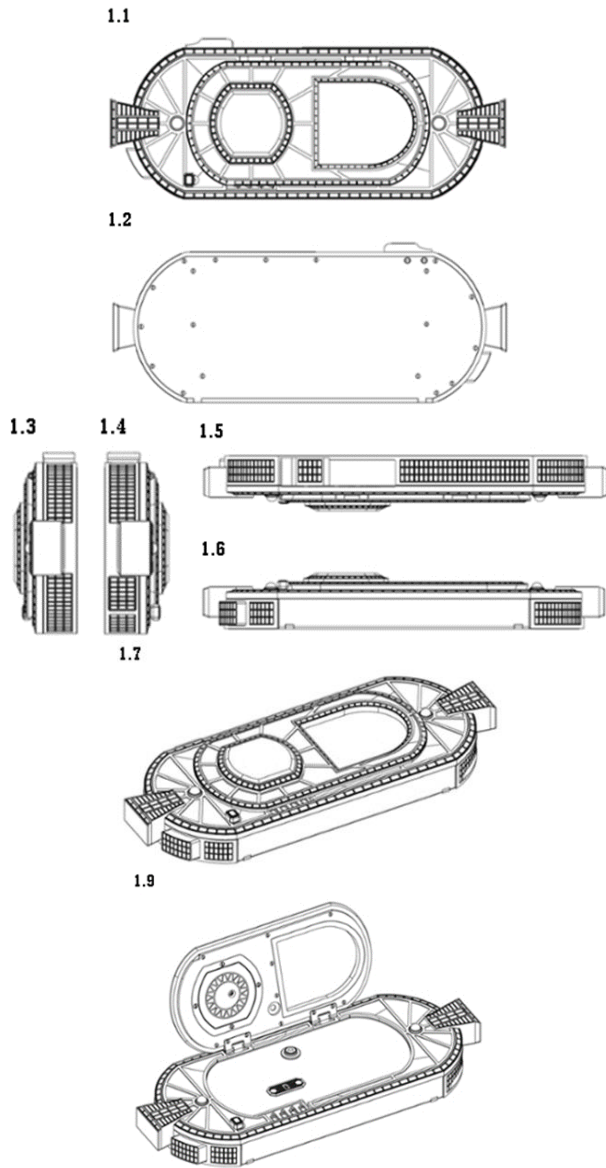

(11) DM/100 324  
(15) 19.03.2018  
(22) 19.03.2018  
(28) 2  
(51) 19-06  
(73) MONTRES JAQUET DROZ SA (MONTRES  
JAQUET DROZ AG) (MONTRES JAQUET  
DROZ LTD.) (CH)  
(72) Christian LATTMANN, Yann LEIGENER  
(54) 1-2. İmza maşını / 1-2. Машина для  
подписи  
(45) 21.09.2018



**Сведения о международной регистрации промышленных образцов,  
охраняемых в Азербайджанской Республике в рамках Женевского акта  
Гаагского соглашения «О международной регистрации промышленных  
образцов»**

Бюллетень № 2. 28.02.2019

2.2



2.3



2.4



2.5



2.6



2.7



2.8



(11) DM/100 900  
(15) 29.03.2018  
(22) 29.03.2018  
(28) 4  
(51) 22-01  
(73) BULGARIAN INDUSTRIAL ENGINEERING COMPANY LTD (BG)  
(72) Emil Ivanov Ivanov  
(54) 1-2. Döyüş sursatı; 3-4. Optik nişangahlı qumbara qurğusu / 1-2. Снаряды; 3-4. Гранатометы с оптическим прицелом  
(45) 05.10.2018

1



2



3



4



(11) DM/100 901  
(15) 29.03.2018  
(22) 29.03.2018  
(28) 1  
(51) 22-01  
(73) BULGARIAN INDUSTRIAL ENGINEERING COMPANY LTD (BG)  
(72) Emil Ivanov Ivanov  
(54) 1. Tapañça / 1. Пистолет  
(45) 05.10.2018

1.1



1.2



(11) DM/103 256  
(15) 11.07.2018  
(22) 11.07.2018  
(28) 2  
(51) 22-06  
(73) SWISSINNO SOLUTIONS AG (CH)  
(72) Gabriel Le Laidier



**“Sənaye nümunələrinin beynəlxalq qeydiyyatı haqqında” Haqq müqaviləsinin Cenevrə aktı çərçivəsində Azərbaycan Respublikasında qorunan sənaye nümunələri barədə məlumatlar**

Bülleten № 2. 28.02.2019

**(54) 1-2. Siçan və siçovullar üçün tələlər /  
1-2. Ловушки для мышей и крыс  
(45) 26.10.2018**

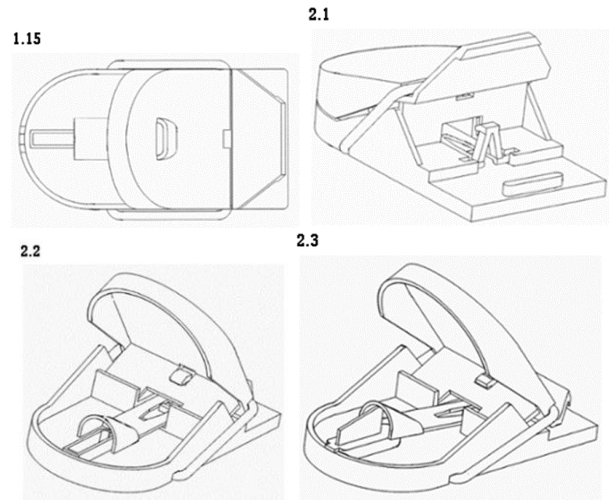
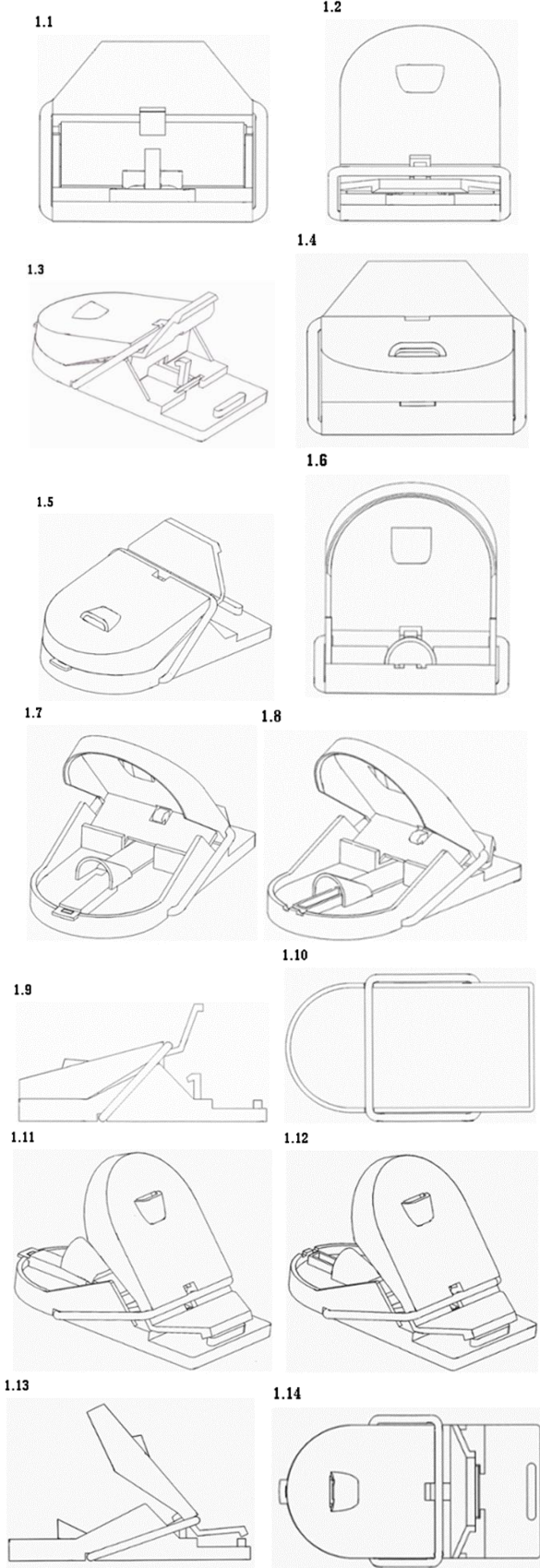

**(11) DM/100 256**

**(15) 07.03.2018**

**(22) 07.03.2018**

**(28) 6**

**(51) 25-03**

**(73) RE-POWER INTERNATIONAL LIMITED**

**(GB)**

**(72) John Corby, Paul Anthony Jarvis, Vadim Opeskin, Mark G Deverell, Andrew Rowley McLelland**

**(54) 1-6. Çardaq / 1-6. Навес**

**(45) 07.09.2018**

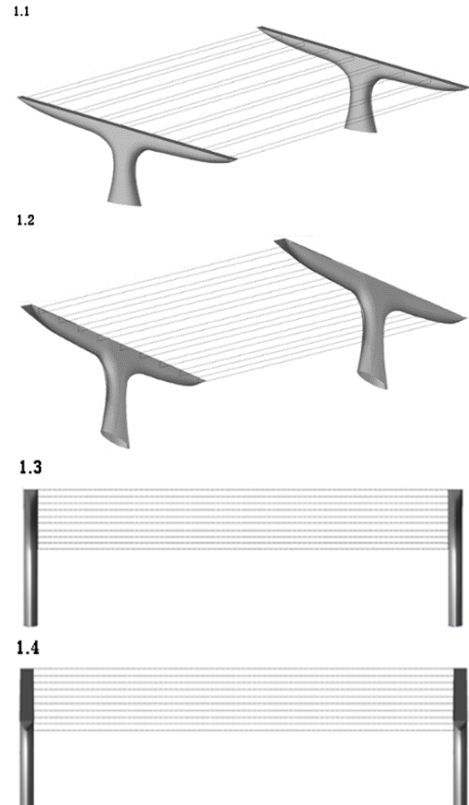

Сведения о международной регистрации промышленных образцов, охраняемых в Азербайджанской Республике в рамках Женевского акта Гаагского соглашения «О международной регистрации промышленных образцов»

Бюллетень № 2. 28.02.2019

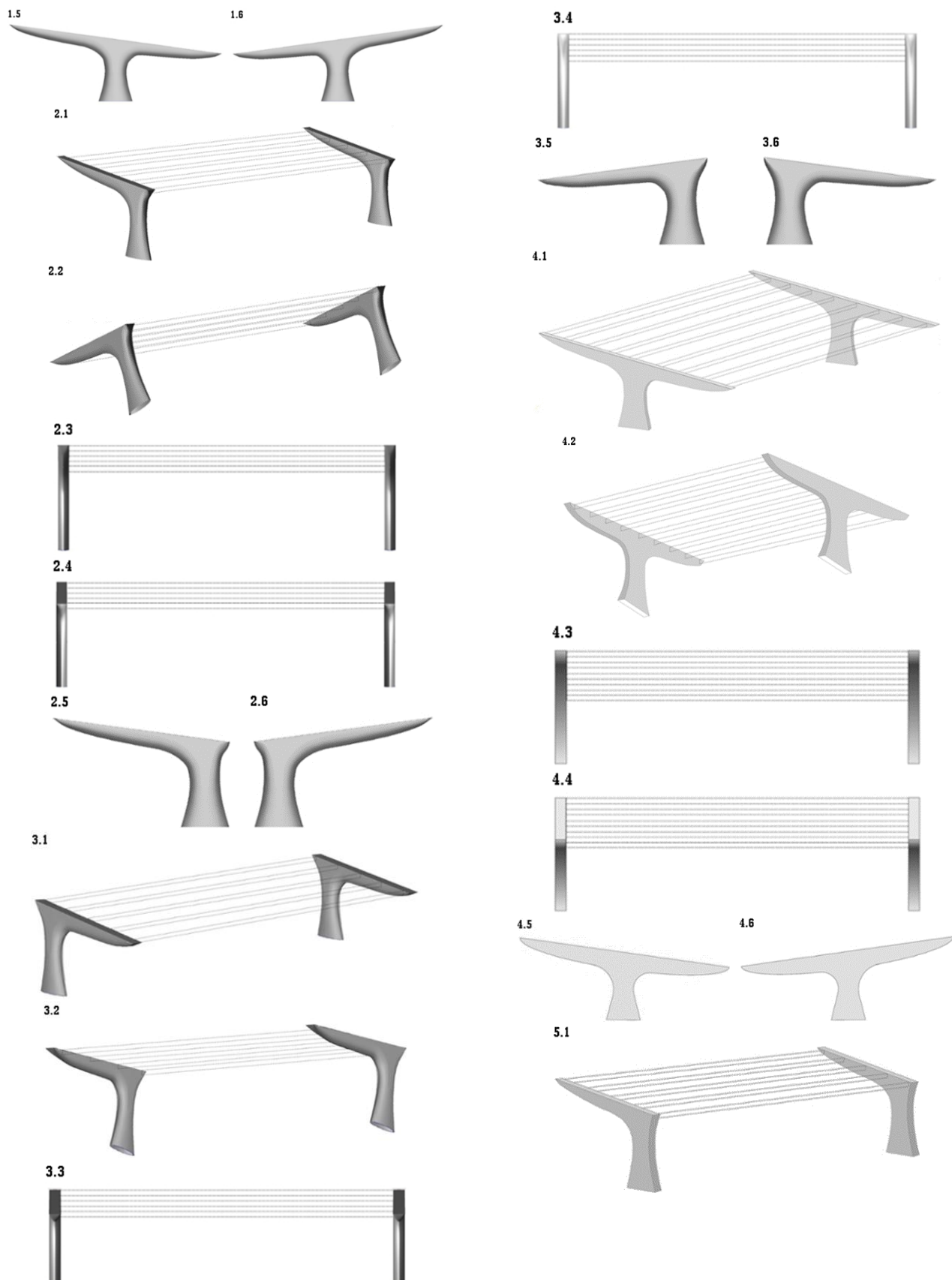

**“Sənaye nümunələrinin beynəlxalq qeydiyyatı haqqında” Haaqa müqaviləsinin Cenevrə aktı çərçivəsində Azərbaycan Respublikasında qorunan sənaye nümunələri barədə məlumatlar**

Bülleten № 2. 28.02.2019

5.2

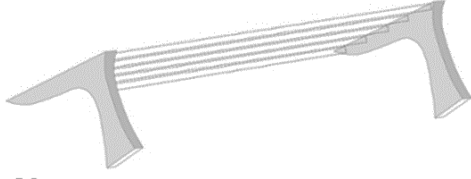

(11) DM/103 583

(15) 17.08.2018

(22) 17.08.2018

(28) 3

(51) 32-00

(73) NORWEGIAN DEFENCE MATERIAL AGENCY (NO)

(72) Norwegian Defence Material Agency

(54) 1-3. Ornament / 1-3. Орнамент

(45) 16.11.2018

5.3



5.4



5.5

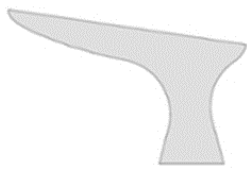

5.6

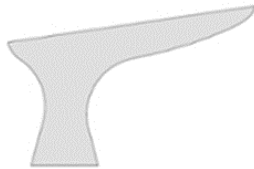

6.1



6.2



6.3



6.4



6.5



6.6

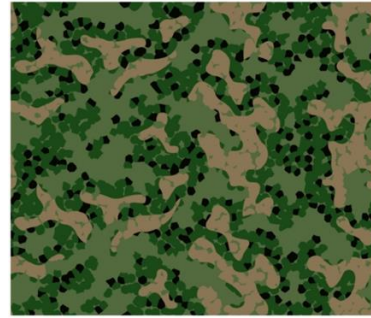
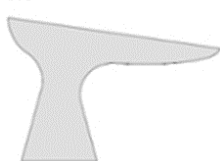

2

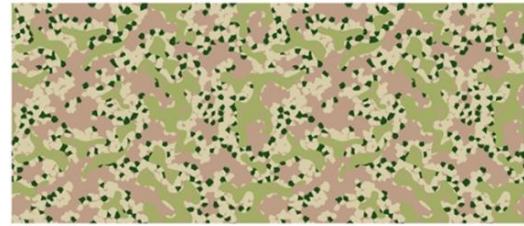

3

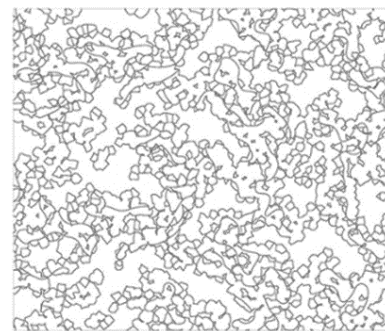

(11) DM/103 690

(15) 16.07.2018

(22) 16.07.2018

(28) 3

(51) 32-00

(73) DAIICHI SANKYO EUROPE GMBH (DE)

(72) Sam Petyan

(54) 1-3. Loqotiplər / 1-3. Логотипы

(45) 23.11.2018

1



2



3



**Avropa İttifaqı ölkələrinin ərazilərində mühafizə olunan  
coğrafi göstəricilərin siyahısı**

**The list of geographical indications that are protected  
within the territory of the European Union countries**

**Список географических указаний, охраняемых  
на территории стран Европейского Союза**

<b>Adı Name Наименование</b>	<b>Latin transkripsiyası Latin Transcription Латинская транскрипция</b>	<b>Ölkə Country Страна</b>	<b>İSO ISO ИСО</b>	<b>Kateqoriyası Cat. Категории</b>	<b>Əmtənin təsnifatı Product Category Товарная классификация</b>
Gailtaler Almkäse		Austria	AT	FOOD	Class 1.3. Cheeses
Gailtaler Speck		Austria	AT	FOOD	Class 1.2. Meat products (cooked, salted, smoked, etc.)
Marchfeldspargel		Austria	AT	FOOD	Class 1.6. Fruit, vegetables and cereals fresh or processed
Mostviertler Birnmost		Austria	AT	FOOD	Class 1.8. other products of Annex I of the Treaty (spices etc.)
Pöllauer Hirschbirne		Austria	AT	FOOD	Class 1.6. Fruit, vegetables and cereals fresh or processed
Steirische Käferbohne		Austria	AT	FOOD	Class 1.6. Fruit, vegetables and cereals fresh or processed
Steirischer Kren		Austria	AT	FOOD	Class 1.6. Fruit, vegetables and cereals fresh or processed
Steirisches Kürbiskernöl		Austria	AT	FOOD	Class 1.5. Oils and fats (butter, margarine, oil, etc.)
Tiroler Almkäse ; Tiroler Alpkäse		Austria	AT	FOOD	Class 1.3. Cheeses
Tiroler Bergkäse		Austria	AT	FOOD	Class 1.3. Cheeses
Tiroler Graukäse		Austria	AT	FOOD	Class 1.3. Cheeses
Tiroler Speck		Austria	AT	FOOD	Class 1.2. Meat products (cooked, salted, smoked, etc.)
Vorarlberger Alpkäse		Austria	AT	FOOD	Class 1.3. Cheeses
Vorarlberger Bergkäse		Austria	AT	FOOD	Class 1.3. Cheeses
Wachauer Marille		Austria	AT	FOOD	Class 1.6. Fruit, vegetables and cereals fresh or processed
Waldviertler Graumohn		Austria	AT	FOOD	Class 1.6. Fruit, vegetables and cereals fresh or processed
Inländerrum		Austria	AT	SPIRITS	Other
Jägertee/Jagertee/Jag atee		Austria	AT	SPIRITS	Liqueur
Mariazeller Magenlikör		Austria	AT	SPIRITS	Liqueur
Steinfelder Magenbitter		Austria	AT	SPIRITS	Liqueur
Wachauer Marillenbrand		Austria	AT	SPIRITS	Fruit spirit
Wachauer Marillenlikör		Austria	AT	SPIRITS	Liqueur
Wachauer Weinbrand		Austria	AT	SPIRITS	Brandy or Weinbrand
Bergland		Austria	AT	WINE	
Burgenland		Austria	AT	WINE	
Carnuntum		Austria	AT	WINE	
Eisenberg		Austria	AT	WINE	
Kamptal		Austria	AT	WINE	
Kärnten		Austria	AT	WINE	

**Avropa İttifaqı ölkələrinin ərazilərində mühafizə olunan  
coğrafi göstəricilərin siyahısı**

**The list of geographical indications that are protected  
within the territory of the European Union countries**

**Список географических указаний, охраняемых  
на территории стран Европейского Союза**

**Bülleten № 2. 28.02.2019**

Kremstal		Austria	AT	WINE	
Mittelburgenland		Austria	AT	WINE	
Neusiedlersee		Austria	AT	WINE	
Neusiedlersee- Hügelland		Austria	AT	WINE	
Niederösterreich		Austria	AT	WINE	
Oberösterreich		Austria	AT	WINE	
Salzburg		Austria	AT	WINE	
Steiermark		Austria	AT	WINE	
Steirerland		Austria	AT	WINE	
Südburgenland		Austria	AT	WINE	
Süd-Oststeiermark		Austria	AT	WINE	
Südsteiermark		Austria	AT	WINE	
Thermenregion		Austria	AT	WINE	
Tirol		Austria	AT	WINE	
Traisental		Austria	AT	WINE	
Vorarlberg		Austria	AT	WINE	
Wachau		Austria	AT	WINE	
Wagram		Austria	AT	WINE	
Weinland		Austria	AT	WINE	
Weinviertel		Austria	AT	WINE	
Weststeiermark		Austria	AT	WINE	
Wien		Austria	AT	WINE	
Beurre d'Ardenne		Belgium	BE	FOOD	Class 1.5. Oils and fats (butter, margarine, oil, etc.)
Brussels grondwitloof		Belgium	BE	FOOD	Class 1.6. Fruit, vegetables and cereals fresh or processed
Fromage de Herve		Belgium	BE	FOOD	Class 1.3. Cheeses
Gentse azalea		Belgium	BE	FOOD	Class 3.5. Flowers and ornamental plants
Geraardsbergse mattentaart		Belgium	BE	FOOD	Class 2.4. Bread, pastry, cakes, confectionery, biscuits and other baker's wares
Jambon d'Ardenne		Belgium	BE	FOOD	Class 1.2. Meat products (cooked, salted, smoked, etc.)
Liers vlaaike		Belgium	BE	FOOD	Class 2.4. Bread, pastry, cakes, confectionery, biscuits and other baker's wares
Pâté gaumais		Belgium	BE	FOOD	Class 1.8. other products of Annex I of the Treaty (spices etc.)
Plate de Florenville		Belgium	BE	FOOD	Class 1.6. Fruit, vegetables and cereals fresh or processed
Poperingse Hopscheuten / Poperingse Hoppescheuten		Belgium	BE	FOOD	Class 1.6. Fruit, vegetables and cereals fresh or processed
Potjesvlees uit de Westhoek		Belgium	BE	FOOD	Class 1.2. Meat products (cooked, salted, smoked, etc.)
Saucisson d'Ardenne / Collier d'Ardenne / Pipe d'Ardenne		Belgium	BE	FOOD	Class 1.2. Meat products (cooked, salted, smoked, etc.)



**Avropa İttifaqı ölkələrinin ərazilərində mühafizə olunan  
coğrafi göstəricilərin siyahısı**

**The list of geographical indications that are protected  
within the territory of the European Union countries.**

**Список географических указаний, охраняемых  
на территории стран Европейского Союза**

**Bülleten № 2. 28.02.2019**

Vlaams-Brabantse tafeldruif		Belgium	BE	FOOD	Class 1.6. Fruit, vegetables and cereals fresh or processed
Vlaamse laurier		Belgium	BE	FOOD	Class 3.5. Flowers and ornamental plants
Balegemse jenever		Belgium	BE	SPIRITS	Juniper-flavoured spirit drinks
Hasseltse jenever/Hasselt		Belgium	BE	SPIRITS	Juniper-flavoured spirit drinks
O' de Flander-Oost-Vlaamse Graanjenever		Belgium	BE	SPIRITS	Juniper-flavoured spirit drinks
Peket-Pekêt/Pèket-Pèkèt de Wallonie		Belgium	BE	SPIRITS	Juniper-flavoured spirit drinks
Côtes de Sambre et Meuse		Belgium	BE	WINE	
Crémant de Wallonie		Belgium	BE	WINE	
Hagelandse wijn		Belgium	BE	WINE	
Haspengouwse wijn		Belgium	BE	WINE	
Heuvellandse wijn		Belgium	BE	WINE	
Maasvallei Limburg		Belgium	BE	WINE	
Vin de pays des jardins de Wallonie		Belgium	BE	WINE	
Vin mousseux de qualité de Wallonie		Belgium	BE	WINE	
Vlaamse landwijn		Belgium	BE	WINE	
Vlaamse mousserende kwaliteitswijn		Belgium	BE	WINE	
Българско розово масло	Bulgarsko rozovo maslo	Bulgaria	BG	FOOD	Class 3.2. Essential oils
Горнооряховски суджук	Gornooryahovski sudzhuk	Bulgaria	BG	FOOD	Class 1.2. Meat products (cooked, salted, smoked, etc.)
Бургаска Мускатова ракия/Мускатова ракия от Бургас	Bourgaska Muscatova rakya/Muscato va rakya from Bourgas	Bulgaria	BG	SPIRITS	Wine spirit
Карловска гроздова ракия/Гроздова Ракия от Карлово	Karlovska grozdova rakya/Grozdov a Rakya from Karlovo	Bulgaria	BG	SPIRITS	Wine spirit
Ловешка сливова ракия/Сливова ракия от Ловеч	Loveshka slivova rakya/Slivova rakya from Lovech	Bulgaria	BG	SPIRITS	Fruit spirit
Поморийска гроздова ракия/Гроздова ракия от Поморие	Pomoriyska grozdova rakya/Grozdov a rakya from Pomorie	Bulgaria	BG	SPIRITS	Wine spirit
Сливенска перла (Сливенска гроздова ракия/Гроздова ракия от Сливен	Slivenska perla (Slivenska grozdova	Bulgaria	BG	SPIRITS	Wine spirit

**Avropa İttifaqı ölkələrinin ərazilərində mühafizə olunan  
coğrafi göstəricilərin siyahısı**

**The list of geographical indications that are protected  
within the territory of the European Union countries**

**Список географических указаний, охраняемых  
на территории стран Европейского Союза**

**Bülleten № 2. 28.02.2019**

	rakya/Grozdov a rakya from Sliven)				
Стралджанска Мускатова ракия/Мускатова ракия от Стралджа	Straldjanska Muscatova rakya/Muscato va rakya from Straldja	Bulgaria	BG	SPIRITS	Wine spirit
Сунгурларска гроздова ракия/Гроздова ракия от Сунгурларе	Sungurlarska grozdova rakya/Grozdov a rakya from Sungurlare	Bulgaria	BG	SPIRITS	Wine spirit
Сухиндолска гроздова ракия/Гроздова ракия от Сухиндол	Suhindolska grozdova rakya/Grozdov a rakya from Suhindol	Bulgaria	BG	SPIRITS	Wine spirit
Троянска сливова ракия/Сливова ракия от Троян	Troyanska slivova rakya/Slivova rakya from Troyan	Bulgaria	BG	SPIRITS	Fruit spirit
Сакар	Sakar	Bulgaria	BG	WINE	
Асеновград	Asenovgrad	Bulgaria	BG	WINE	
Болярово	Bolyarovo	Bulgaria	BG	WINE	
Брестник	Brestnik	Bulgaria	BG	WINE	
Варна	Varna	Bulgaria	BG	WINE	
Велики Преслав	Veliki Preslav	Bulgaria	BG	WINE	
Видин	Vidin	Bulgaria	BG	WINE	
Враца	Vratsa	Bulgaria	BG	WINE	
Върбица	Varbitsa	Bulgaria	BG	WINE	
Долината на Струма	Struma valley	Bulgaria	BG	WINE	
Драгоево	Dragoevo	Bulgaria	BG	WINE	
Дунавска равнина	Danube Plain	Bulgaria	BG	WINE	
Евксиноград	Evksinograd	Bulgaria	BG	WINE	
Ивайловград	Ivaylovgrad	Bulgaria	BG	WINE	
Карлово	Karlovo	Bulgaria	BG	WINE	
Карнобат	Karnobat	Bulgaria	BG	WINE	
Ловеч	Lovech	Bulgaria	BG	WINE	
Лозица	Lozitsa	Bulgaria	BG	WINE	
Лом	Lom	Bulgaria	BG	WINE	
Любимец	Lyubimets	Bulgaria	BG	WINE	
Лясковец	Lyaskovets	Bulgaria	BG	WINE	
Мелник	Melnik	Bulgaria	BG	WINE	
Монтана	Montana	Bulgaria	BG	WINE	
Нова Загора	Nova Zagora	Bulgaria	BG	WINE	
Нови Пазар	Novi Pazar	Bulgaria	BG	WINE	
Ново село	Novo Selo	Bulgaria	BG	WINE	
Оряховица	Oryahovitsa	Bulgaria	BG	WINE	
Павликени	Pavlikeni	Bulgaria	BG	WINE	
Пазарджик	Pazardjik	Bulgaria	BG	WINE	

**Avropa İttifaqı ölkələrinin ərazilərində mühafizə olunan  
coğrafi göstəricilərin siyahısı**

**The list of geographical indications that are protected  
within the territory of the European Union countries.**

**Список географических указаний, охраняемых  
на территории стран Европейского Союза**

**Bülleten № 2. 28.02.2019**

Перущица	Perushtitsa	Bulgaria	BG	WINE	
Плевен	Pleven	Bulgaria	BG	WINE	
Пловдив	Plovdiv	Bulgaria	BG	WINE	
Поморие	Pomorie	Bulgaria	BG	WINE	
Русе	Ruse	Bulgaria	BG	WINE	
Сандански	Sandanski	Bulgaria	BG	WINE	
Свищов	Svishtov	Bulgaria	BG	WINE	
Септември	Septemvri	Bulgaria	BG	WINE	
Славянци	Slavyantsi	Bulgaria	BG	WINE	
Сливен	Sliven	Bulgaria	BG	WINE	
Стамболово	Stambolovo	Bulgaria	BG	WINE	
Стара Загора	Stara Zagora	Bulgaria	BG	WINE	
Сунгурларе	Sungurlare	Bulgaria	BG	WINE	
Сухиндол	Suhindol	Bulgaria	BG	WINE	
Тракийска низина	Thracian Lowlands	Bulgaria	BG	WINE	
Търговище	Targovishte	Bulgaria	BG	WINE	
Хан Крум	Khan Krum	Bulgaria	BG	WINE	
Хасково	Haskovo	Bulgaria	BG	WINE	
Хисаря	Hisarya	Bulgaria	BG	WINE	
Хърсово	Harsovo	Bulgaria	BG	WINE	
Черноморски район	Black Sea Region	Bulgaria	BG	WINE	
Шивачево	Shivachevo	Bulgaria	BG	WINE	
Шумен	Shumen	Bulgaria	BG	WINE	
Южно Черноморие	Southern Black Sea Coast	Bulgaria	BG	WINE	
Ямбол	Yambol	Bulgaria	BG	WINE	
Baranjski kulen		Croatia	HR	FOOD	Class 1.2. Meat products (cooked, salted, smoked, etc.)
Dalmatinski pršut		Croatia	HR	FOOD	Class 1.2. Meat products (cooked, salted, smoked, etc.)
Drnjski pršut		Croatia	HR	FOOD	Class 1.2. Meat products (cooked, salted, smoked, etc.)
Ekstra djevičansko maslinovo ulje Cres		Croatia	HR	FOOD	Class 1.5. Oils and fats (butter, margarine, oil, etc.)
Korčulansko maslinovo ulje		Croatia	HR	FOOD	Class 1.5. Oils and fats (butter, margarine, oil, etc.)
Krčki pršut		Croatia	HR	FOOD	Class 1.2. Meat products (cooked, salted, smoked, etc.)
Krčko maslinovo ulje		Croatia	HR	FOOD	Class 1.5. Oils and fats (butter, margarine, oil, etc.)
Lički krumpir		Croatia	HR	FOOD	Class 1.6. Fruit, vegetables and cereals fresh or processed
Međimursko meso 'z tiblice		Croatia	HR	FOOD	Class 1.2. Meat products (cooked, salted, smoked, etc.)
Neretvanska mandarina		Croatia	HR	FOOD	Class 1.6. Fruit, vegetables and cereals fresh or processed
Ogulinski kiseli kupus/Ogulinsko kiselo zelje		Croatia	HR	FOOD	Class 1.6. Fruit, vegetables and cereals fresh or processed

**Avropa İttifaqı ölkələrinin ərazilərində mühafizə olunan  
coğrafi göstəricilərin siyahısı**

**The list of geographical indications that are protected  
within the territory of the European Union countries**

**Список географических указаний, охраняемых  
на территории стран Европейского Союза**

**Bülleten № 2. 28.02.2019**

Paška janjetina		Croatia	HR	FOOD	Class 1.1. Fresh meat (and offal)
Poljički soparnik / Poljički zeljanik / Poljički uljenjak		Croatia	HR	FOOD	Class 2.4. Bread, pastry, cakes, confectionery, biscuits and other baker's wares
Slavonski kulen / Slavonski kulin		Croatia	HR	FOOD	Class 1.2. Meat products (cooked, salted, smoked, etc.)
Slavonski Med		Croatia	HR	FOOD	Class 1.4. Other products of animal origin (eggs, honey, various dairy products except butter, etc.)
Šoltansko maslinovo ulje		Croatia	HR	FOOD	Class 1.5. Oils and fats (butter, margarine, oil, etc.)
Varaždinsko zelje		Croatia	HR	FOOD	Class 1.6. Fruit, vegetables and cereals fresh or processed
Zagorski puran		Croatia	HR	FOOD	Class 1.1. Fresh meat (and offal)
Hrvatska loza		Croatia	HR	SPIRITS	Fruit spirit
Hrvatska stara šljivovica		Croatia	HR	SPIRITS	Fruit spirit
Hrvatska travarica		Croatia	HR	SPIRITS	Other
Hrvatski pelinkovac		Croatia	HR	SPIRITS	Liqueur
Slavonska šljivovica		Croatia	HR	SPIRITS	Fruit spirit
Zadarski maraschino		Croatia	HR	SPIRITS	Maraschino, Marrasquino or Maraskino
Dalmatinska zagora		Croatia	HR	WINE	
Dingač		Croatia	HR	WINE	
Hrvatska Istra		Croatia	HR	WINE	
Hrvatsko Podunavlje		Croatia	HR	WINE	
Hrvatsko primorje		Croatia	HR	WINE	
Istočna kontinentalna Hrvatska		Croatia	HR	WINE	
Moslavina		Croatia	HR	WINE	
Plešivica		Croatia	HR	WINE	
Pokuplje		Croatia	HR	WINE	
Prigorje-Bilogora		Croatia	HR	WINE	
Primorska Hrvatska		Croatia	HR	WINE	
Sjeverna Dalmacija		Croatia	HR	WINE	
Slavonija		Croatia	HR	WINE	
Srednja i Južna Dalmacija		Croatia	HR	WINE	
Zagorje – Međimurje		Croatia	HR	WINE	
Zapadna kontinentalna Hrvatska		Croatia	HR	WINE	
Istarski pršut / Istrski pršut		Croatia/ Slovenia	HR/S I	FOOD	Class 1.2. Meat products (cooked, salted, smoked, etc.)
Γλυκό Τριαντάφυλλο Αγρού	Glyko Triantafyllo Agrou	Cyprus	CY	FOOD	Class 2.4. Bread, pastry, cakes, confectionery, biscuits and other baker's wares
Κολοκάσι Σωτήρας / Κολοκάσι-Πούλλες Σωτήρας	Kolokasi Sotiras / Kolokasi-Poullés Sotiras	Cyprus	CY	FOOD	Class 1.6. Fruit, vegetables and cereals fresh or processed

**Avropa İttifaqı ölkələrinin ərazilərində mühafizə olunan  
coğrafi göstəricilərin siyahısı**

**The list of geographical indications that are protected  
within the territory of the European Union countries.**

**Список географических указаний, охраняемых  
на территории стран Европейского Союза**

**Bülleten № 2. 28.02.2019**

Κουφέτα Αμυγδάλου Γεροσκήπου	Koufeta Amygdalou Geroskipou	Cyprus	CY	FOOD	Class 2.4. Bread, pastry, cakes, confectionery, biscuits and other baker's wares
Λουκούμι Γεροσκήπου	Loukoumi Geroskipou	Cyprus	CY	FOOD	Class 2.4. Bread, pastry, cakes, confectionery, biscuits and other baker's wares
Παφίτικο Λουκάνικο	Pafitiko Loukaniko	Cyprus	CY	FOOD	Class 1.2. Meat products (cooked, salted, smoked, etc.)
Ζιβανία/Τζιβανία/Ζιβάν α	Zivania	Cyprus	CY	SPIRITS	Grape marc spirit or grape marc
Βουνί Παναγιάς – Αμπελίτης	Vouni Panayias - Ampelitis	Cyprus	CY	WINE	
Κουμανδάρια	Commandaria	Cyprus	CY	WINE	
Κρασοχώρια Λεμεσού	Krasohoria Lemesou	Cyprus	CY	WINE	
Κρασοχώρια Λεμεσού - Αφάμης	Krasohoria Lemesou - Afames	Cyprus	CY	WINE	
Κρασοχώρια Λεμεσού - Λαόνα	Krasohoria Lemesou - Laona	Cyprus	CY	WINE	
Λαόνα Ακάμα	Laona Akama	Cyprus	CY	WINE	
Λάρνακα	Larnaka	Cyprus	CY	WINE	
Λεμεσός	Lemesos	Cyprus	CY	WINE	
Λευκωσία	Lefkosia	Cyprus	CY	WINE	
Πάφος	Pafos	Cyprus	CY	WINE	
Πιτσιλιά	Pitsilia	Cyprus	CY	WINE	
Březnický ležák		Czech Republic	CZ	FOOD	Class 2.1. Beers
Brněnské pivo ; Starobrněnské pivo		Czech Republic	CZ	FOOD	Class 2.1. Beers
Budějovické pivo		Czech Republic	CZ	FOOD	Class 2.1. Beers
Budějovický měšťanský var		Czech Republic	CZ	FOOD	Class 2.1. Beers
Černá Hora		Czech Republic	CZ	FOOD	Class 2.1. Beers
České pivo		Czech Republic	CZ	FOOD	Class 2.1. Beers
Českobudějovické pivo		Czech Republic	CZ	FOOD	Class 2.1. Beers
Český kmín		Czech Republic	CZ	FOOD	Class 1.8. other products of Annex I of the Treaty (spices etc.)
Chamomilla bohémica		Czech Republic	CZ	FOOD	Class 1.8. other products of Annex I of the Treaty (spices etc.)
Chelčicko — Lhenické ovoce		Czech Republic	CZ	FOOD	Class 1.6. Fruit, vegetables and cereals fresh or processed
Chodské pivo		Czech Republic	CZ	FOOD	Class 2.1. Beers

**Avropa İttifaqı ölkələrinin ərazilərində mühafizə olunan  
coğrafi göstəricilərin siyahısı**

**The list of geographical indications that are protected  
within the territory of the European Union countries**

**Список географических указаний, охраняемых  
на территории стран Европейского Союза**

**Bülleten № 2. 28.02.2019**

Hořické trubičky		Czech Republic	CZ	FOOD	Class 2.4. Bread, pastry, cakes, confectionery, biscuits and other baker's wares
Jihočeská Niva		Czech Republic	CZ	FOOD	Class 1.3. Cheeses
Jihočeská Zlatá Niva		Czech Republic	CZ	FOOD	Class 1.3. Cheeses
Karlovarské oplatky		Czech Republic	CZ	FOOD	Class 2.4. Bread, pastry, cakes, confectionery, biscuits and other baker's wares
Karlovarské trojhránky		Czech Republic	CZ	FOOD	Class 2.4. Bread, pastry, cakes, confectionery, biscuits and other baker's wares
Karlovarský suchar		Czech Republic	CZ	FOOD	Class 2.4. Bread, pastry, cakes, confectionery, biscuits and other baker's wares
Lomnické suchary		Czech Republic	CZ	FOOD	Class 2.4. Bread, pastry, cakes, confectionery, biscuits and other baker's wares
Mariánskolázeňské oplatky		Czech Republic	CZ	FOOD	Class 2.4. Bread, pastry, cakes, confectionery, biscuits and other baker's wares
Nošovické kysané zelí		Czech Republic	CZ	FOOD	Class 1.6. Fruit, vegetables and cereals fresh or processed
Olomoucké tvarůžky		Czech Republic	CZ	FOOD	Class 1.3. Cheeses
Pardubický perník		Czech Republic	CZ	FOOD	Class 2.4. Bread, pastry, cakes, confectionery, biscuits and other baker's wares
Pohořelický kapr		Czech Republic	CZ	FOOD	Class 1.7. Fresh fish, molluscs, and crustaceans and products derived therefrom
Štramberské uši		Czech Republic	CZ	FOOD	Class 2.4. Bread, pastry, cakes, confectionery, biscuits and other baker's wares
Třeboňský kapr		Czech Republic	CZ	FOOD	Class 1.7. Fresh fish, molluscs, and crustaceans and products derived therefrom
Valašský frgál		Czech Republic	CZ	FOOD	Class 2.4. Bread, pastry, cakes, confectionery, biscuits and other baker's wares
Všestarská cibule		Czech Republic	CZ	FOOD	Class 1.6. Fruit, vegetables and cereals fresh or processed
Žatecký chmel		Czech Republic	CZ	FOOD	Class 1.8. other products of Annex I of the Treaty (spices etc.)
Znojemské pivo		Czech Republic	CZ	FOOD	Class 2.1. Beers
Karlovarská Hořká		Czech Republic	CZ	SPIRITS	Liqueur
Čechy		Czech Republic	CZ	WINE	

**Avropa İttifaqı ölkələrinin ərazilərində mühafizə olunan  
coğrafi göstəricilərin siyahısı**

**The list of geographical indications that are protected  
within the territory of the European Union countries.**

**Список географических указаний, охраняемых  
на территории стран Европейского Союза**

**Bülleten № 2. 28.02.2019**

české		Czech Republic	CZ	WINE	
Litoměřická		Czech Republic	CZ	WINE	
Mělnická		Czech Republic	CZ	WINE	
Mikulovská		Czech Republic	CZ	WINE	
Morava		Czech Republic	CZ	WINE	
moravské		Czech Republic	CZ	WINE	
Novosedelské Slámové víno		Czech Republic	CZ	WINE	
Slovácká		Czech Republic	CZ	WINE	
Šobes		Czech Republic	CZ	WINE	
Šobeské víno		Czech Republic	CZ	WINE	
Velkopavlovická		Czech Republic	CZ	WINE	
Znojmská		Czech Republic	CZ	WINE	
Znojmo		Czech Republic	CZ	WINE	
Danablu		Denmark	DK	FOOD	Class 1.3. Cheeses
Danbo		Denmark	DK	FOOD	Class 1.3. Cheeses
Esrom		Denmark	DK	FOOD	Class 1.3. Cheeses
Lammefjordsgulerod		Denmark	DK	FOOD	Class 1.6. Fruit, vegetables and cereals fresh or processed
Lammefjordskartofler		Denmark	DK	FOOD	Class 1.6. Fruit, vegetables and cereals fresh or processed
Vadehavslam		Denmark	DK	FOOD	Class 1.1. Fresh meat (and offal)
Vadehavsstude		Denmark	DK	FOOD	Class 1.1. Fresh meat (and offal)
Bornholm		Denmark	DK	WINE	
Dons		Denmark	DK	WINE	
Fyn		Denmark	DK	WINE	
Jylland		Denmark	DK	WINE	
Sjælland		Denmark	DK	WINE	
Estonian vodka		Estonia	EE	SPIRITS	Vodka
Kainuun rönttönen		Finland	FI	FOOD	Class 2.4. Bread, pastry, cakes, confectionery, biscuits and other baker's wares
Kitkan viisas		Finland	FI	FOOD	Class 1.7. Fresh fish, molluscs, and crustaceans and products derived therefrom
Lapin Poron kuivaliha		Finland	FI	FOOD	Class 1.2. Meat products (cooked, salted, smoked, etc.)
Lapin Poron kylmäsavuliha		Finland	FI	FOOD	Class 1.2. Meat products (cooked, salted, smoked, etc.)

**Avropa İttifaqı ölkələrinin ərazilərində mühafizə olunan  
coğrafi göstəricilərin siyahısı**

**The list of geographical indications that are protected  
within the territory of the European Union countries**

**Список географических указаний, охраняемых  
на территории стран Европейского Союза**

**Bülleten № 2. 28.02.2019**

Lapin Poron liha		Finland	FI	FOOD	Class 1.1. Fresh meat (and offal)
Lapin Puikula		Finland	FI	FOOD	Class 1.6. Fruit, vegetables and cereals fresh or processed
Puruveden muikku		Finland	FI	FOOD	Class 1.7. Fresh fish, molluscs, and crustaceans and products derived therefrom
Suomalainen Marjalikööri/Suomalainen Hedelmälikööri/Finsk Bärlikör/Finsk Fruktlikör/Finnish berry liqueur/Finnish fruit liqueur		Finland	FI	SPIRITS	Liqueur
Suomalainen Vodka/Finsk Vodka/Vodka of Finland		Finland	FI	SPIRITS	Vodka
Abondance		France	FR	FOOD	Class 1.3. Cheeses
Abricots rouges du Roussillon		France	FR	FOOD	Class 1.6. Fruit, vegetables and cereals fresh or processed
Agneau de lait des Pyrénées		France	FR	FOOD	Class 1.1. Fresh meat (and offal)
Agneau de l'Aveyron		France	FR	FOOD	Class 1.1. Fresh meat (and offal)
Agneau de Lozère		France	FR	FOOD	Class 1.1. Fresh meat (and offal)
Agneau de Pauillac		France	FR	FOOD	Class 1.1. Fresh meat (and offal)
Agneau de Sisteron		France	FR	FOOD	Class 1.1. Fresh meat (and offal)
Agneau du Bourbonnais		France	FR	FOOD	Class 1.1. Fresh meat (and offal)
Agneau du Limousin		France	FR	FOOD	Class 1.1. Fresh meat (and offal)
Agneau du Périgord		France	FR	FOOD	Class 1.1. Fresh meat (and offal)
Agneau du Poitou-Charentes		France	FR	FOOD	Class 1.1. Fresh meat (and offal)
Agneau du Quercy		France	FR	FOOD	Class 1.1. Fresh meat (and offal)
Ail blanc de Lomagne		France	FR	FOOD	Class 1.6. Fruit, vegetables and cereals fresh or processed
Ail de la Drôme		France	FR	FOOD	Class 1.6. Fruit, vegetables and cereals fresh or processed
Ail fumé d'Arleux		France	FR	FOOD	Class 1.6. Fruit, vegetables and cereals fresh or processed
Ail rose de Lautrec		France	FR	FOOD	Class 1.6. Fruit, vegetables and cereals fresh or processed
Ail violet de Cadours		France	FR	FOOD	Class 1.6. Fruit, vegetables and cereals fresh or processed



**Avropa İttifaqı ölkələrinin ərazilərində mühafizə olunan  
coğrafi göstəricilərin siyahısı**

**The list of geographical indications that are protected  
within the territory of the European Union countries.**

**Список географических указаний, охраняемых  
на территории стран Европейского Союза**

**Bülleten № 2. 28.02.2019**

Anchois de Collioure		France	FR	FOOD	Class 1.7. Fresh fish, molluscs, and crustaceans and products derived therefrom
Artichaut du Roussillon		France	FR	FOOD	Class 1.6. Fruit, vegetables and cereals fresh or processed
Asperge des sables des Landes		France	FR	FOOD	Class 1.6. Fruit, vegetables and cereals fresh or processed
Asperges du Blayais		France	FR	FOOD	Class 1.6. Fruit, vegetables and cereals fresh or processed
Banon		France	FR	FOOD	Class 1.3. Cheeses
Barèges-Gavarnie		France	FR	FOOD	Class 1.1. Fresh meat (and offal)
Béa du Roussillon		France	FR	FOOD	Class 1.6. Fruit, vegetables and cereals fresh or processed
Beaufort		France	FR	FOOD	Class 1.3. Cheeses
Bergamote(s) de Nancy		France	FR	FOOD	Class 2.4. Bread, pastry, cakes, confectionery, biscuits and other baker's wares
Beurre Charentes-Poitou ; Beurre des Charentes ; Beurre des Deux-Sèvres		France	FR	FOOD	Class 1.5. Oils and fats (butter, margarine, oil, etc.)
Beurre de Bresse		France	FR	FOOD	Class 1.5. Oils and fats (butter, margarine, oil, etc.)
Beurre d'Isigny		France	FR	FOOD	Class 1.5. Oils and fats (butter, margarine, oil, etc.)
Bleu d'Auvergne		France	FR	FOOD	Class 1.3. Cheeses
Bleu de Gex Haut-Jura ; Bleu de Septmoncel		France	FR	FOOD	Class 1.3. Cheeses
Bleu des Causses		France	FR	FOOD	Class 1.3. Cheeses
Bleu du Vercors-Sassenage		France	FR	FOOD	Class 1.3. Cheeses
Bœuf charolais du Bourbonnais		France	FR	FOOD	Class 1.1. Fresh meat (and offal)
Bœuf de Bazas		France	FR	FOOD	Class 1.1. Fresh meat (and offal)
Bœuf de Chalosse		France	FR	FOOD	Class 1.1. Fresh meat (and offal)
Bœuf de Charolles		France	FR	FOOD	Class 1.1. Fresh meat (and offal)
Boeuf de Vendée		France	FR	FOOD	Class 1.1. Fresh meat (and offal)
Bœuf du Maine		France	FR	FOOD	Class 1.1. Fresh meat (and offal)
Boudin blanc de Rethel		France	FR	FOOD	Class 1.2. Meat products (cooked, salted, smoked, etc.)
Brie de Meaux		France	FR	FOOD	Class 1.3. Cheeses
Brie de Melun		France	FR	FOOD	Class 1.3. Cheeses
Brillat-Savarin		France	FR	FOOD	Class 1.3. Cheeses
Brioche vendéenne		France	FR	FOOD	Class 2.4. Bread, pastry, cakes, confectionery, biscuits and other baker's wares

**Avropa İttifaqı ölkələrinin ərazilərində mühafizə olunan  
coğrafi göstəricilərin siyahısı**

**The list of geographical indications that are protected  
within the territory of the European Union countries**

**Список географических указаний, охраняемых  
на территории стран Европейского Союза**

**Bülleten № 2. 28.02.2019**

Brocciu Corse / Brocciu		France	FR	FOOD	Class 1.3. Cheeses
Camembert de Normandie		France	FR	FOOD	Class 1.3. Cheeses
Canard à foie gras du Sud-Ouest (Chalosse, Gascogne, Gers, Landes, Périgord, Quercy)		France	FR	FOOD	Class 1.2. Meat products (cooked, salted, smoked, etc.)
Cantal ; fourme de Cantal ; cantalet		France	FR	FOOD	Class 1.3. Cheeses
Chabichou du Poitou		France	FR	FOOD	Class 1.3. Cheeses
Chaource		France	FR	FOOD	Class 1.3. Cheeses
Chapon du Périgord		France	FR	FOOD	Class 1.1. Fresh meat (and offal)
Charolais		France	FR	FOOD	Class 1.3. Cheeses
Charolais de Bourgogne		France	FR	FOOD	Class 1.1. Fresh meat (and offal)
Chasselas de Moissac		France	FR	FOOD	Class 1.6. Fruit, vegetables and cereals fresh or processed
Châtaigne d'Ardèche		France	FR	FOOD	Class 1.6. Fruit, vegetables and cereals fresh or processed
Chevrotin		France	FR	FOOD	Class 1.3. Cheeses
Cidre de Bretagne ; Cidre Breton		France	FR	FOOD	Class 1.8. other products of Annex I of the Treaty (spices etc.)
Cidre de Normandie ; Cidre Normand		France	FR	FOOD	Class 1.8. other products of Annex I of the Treaty (spices etc.)
Citron de Menton		France	FR	FOOD	Class 1.6. Fruit, vegetables and cereals fresh or processed
Clémentine de Corse		France	FR	FOOD	Class 1.6. Fruit, vegetables and cereals fresh or processed
Coco de Paimpol		France	FR	FOOD	Class 1.6. Fruit, vegetables and cereals fresh or processed
Comté		France	FR	FOOD	Class 1.3. Cheeses
Coppa de Corse / Coppa de Corse - Coppa di Corsica		France	FR	FOOD	Class 1.2. Meat products (cooked, salted, smoked, etc.)
Coquille Saint-Jacques des Côtes d'Armor		France	FR	FOOD	Class 1.7. Fresh fish, molluscs, and crustaceans and products derived therefrom
Cornouaille		France	FR	FOOD	Class 1.8. other products of Annex I of the Treaty (spices etc.)
Crème de Bresse		France	FR	FOOD	Class 1.4. Other products of animal origin (eggs, honey, various dairy products except butter, etc.)
Crème d'Isigny		France	FR	FOOD	Class 1.4. Other products of animal origin (eggs, honey, various dairy products except butter, etc.)

**Avropa İttifaqı ölkələrinin ərazilərində mühafizə olunan  
coğrafi göstəricilərin siyahısı**

**The list of geographical indications that are protected  
within the territory of the European Union countries.**

**Список географических указаний, охраняемых  
на территории стран Европейского Союза**

**Bülleten № 2. 28.02.2019**

Crème fraîche fluide d'Alsace		France	FR	FOOD	Class 1.4. Other products of animal origin (eggs, honey, various dairy products except butter, etc.)
Crottin de Chavignol / Chavignol		France	FR	FOOD	Class 1.3. Cheeses
Dinde de Bresse		France	FR	FOOD	Class 1.1. Fresh meat (and offal)
Domfront		France	FR	FOOD	Class 1.8. other products of Annex I of the Treaty (spices etc.)
Echalote d'Anjou		France	FR	FOOD	Class 1.6. Fruit, vegetables and cereals fresh or processed
Emmental de Savoie		France	FR	FOOD	Class 1.3. Cheeses
Emmental français est-central		France	FR	FOOD	Class 1.3. Cheeses
Époisses		France	FR	FOOD	Class 1.3. Cheeses
Farine de blé noir de Bretagne/Farine de blé noir de Bretagne — Gwinizh du Breizh		France	FR	FOOD	Class 1.6. Fruit, vegetables and cereals fresh or processed
Farine de châtaigne corse/Farina castagnina corsa		France	FR	FOOD	Class 1.6. Fruit, vegetables and cereals fresh or processed
Farine de Petit Épeautre de Haute Provence		France	FR	FOOD	Class 1.6. Fruit, vegetables and cereals fresh or processed
Figue de Solliès		France	FR	FOOD	Class 1.6. Fruit, vegetables and cereals fresh or processed
Fin Gras/ Fin Gras du Mézenc		France	FR	FOOD	Class 1.1. Fresh meat (and offal)
Foin de Crau		France	FR	FOOD	Classe 3.1. Foin
Fourme d'Ambert		France	FR	FOOD	Class 1.3. Cheeses
Fourme de Montbrison		France	FR	FOOD	Class 1.3. Cheeses
Fraise du Périgord		France	FR	FOOD	Class 1.6. Fruit, vegetables and cereals fresh or processed
Fraises de Nîmes		France	FR	FOOD	Class 1.6. Fruit, vegetables and cereals fresh or processed
Gâche vendéenne		France	FR	FOOD	Class 2.4. Bread, pastry, cakes, confectionery, biscuits and other baker's wares
Génisse Fleur d'Aubrac		France	FR	FOOD	Class 1.1. Fresh meat (and offal)
Gruyère		France	FR	FOOD	Class 1.3. Cheeses
Haricot tarbais		France	FR	FOOD	Class 1.6. Fruit, vegetables and cereals fresh or processed
Huile d'olive d'Aix-en-Provence		France	FR	FOOD	Class 1.5. Oils and fats (butter, margarine, oil, etc.)
Huile d'olive de Corse / Huile d'olive de Corse - Oliu di Corsica		France	FR	FOOD	Class 1.5. Oils and fats (butter, margarine, oil, etc.)
Huile d'olive de Haute-Provence		France	FR	FOOD	Class 1.5. Oils and fats (butter, margarine, oil, etc.)

**Avropa İttifaqı ölkələrinin ərazilərində mühafizə olunan  
coğrafi göstəricilərin siyahısı**

**The list of geographical indications that are protected  
within the territory of the European Union countries**

**Список географических указаний, охраняемых  
на территории стран Европейского Союза**

**Bülleten № 2. 28.02.2019**

Huile d'olive de la Vallée des Baux-de-Provence		France	FR	FOOD	Class 1.5. Oils and fats (butter, margarine, oil, etc.)
Huile d'olive de Nice		France	FR	FOOD	Class 1.5. Oils and fats (butter, margarine, oil, etc.)
Huile d'olive de Nîmes		France	FR	FOOD	Class 1.5. Oils and fats (butter, margarine, oil, etc.)
Huile d'olive de Nyons		France	FR	FOOD	Class 1.5. Oils and fats (butter, margarine, oil, etc.)
Huile essentielle de lavande de Haute-Provence / Essence de lavande de Haute-Provence		France	FR	FOOD	Class 3.2. Essential oils
Huîtres Marennes Oléron		France	FR	FOOD	Class 1.7. Fresh fish, molluscs, and crustaceans and products derived therefrom
Jambon d'Auvergne		France	FR	FOOD	Class 1.2. Meat products (cooked, salted, smoked, etc.)
Jambon de Bayonne		France	FR	FOOD	Class 1.2. Meat products (cooked, salted, smoked, etc.)
Jambon de Lacaune		France	FR	FOOD	Class 1.2. Meat products (cooked, salted, smoked, etc.)
Jambon de l'Ardèche		France	FR	FOOD	Class 1.2. Meat products (cooked, salted, smoked, etc.)
Jambon de Vendée		France	FR	FOOD	Class 1.2. Meat products (cooked, salted, smoked, etc.)
Jambon noir de Bigorre		France	FR	FOOD	Class 1.2. Meat products (cooked, salted, smoked, etc.)
Jambon sec de Corse / Jambon sec de Corse - Prisuttu		France	FR	FOOD	Class 1.2. Meat products (cooked, salted, smoked, etc.)
Jambon sec des Ardennes / Noix de Jambon sec des Ardennes		France	FR	FOOD	Class 1.2. Meat products (cooked, salted, smoked, etc.)
Kintoa		France	FR	FOOD	Class 1.1. Fresh meat (and offal)
Kivi de l'Adour		France	FR	FOOD	Class 1.6. Fruit, vegetables and cereals fresh or processed
Laguiole		France	FR	FOOD	Class 1.3. Cheeses
Langres		France	FR	FOOD	Class 1.3. Cheeses
Lentille verte du Puy		France	FR	FOOD	Class 1.6. Fruit, vegetables and cereals fresh or processed
Lentilles vertes du Berry		France	FR	FOOD	Class 1.6. Fruit, vegetables and cereals fresh or processed
Lingot du Nord		France	FR	FOOD	Class 1.6. Fruit, vegetables and cereals fresh or processed
Livarot		France	FR	FOOD	Class 1.3. Cheeses
Lonzo de Corse / Lonzo de Corse - Lonzu		France	FR	FOOD	Class 1.2. Meat products (cooked, salted, smoked, etc.)

**Avropa İttifaqı ölkələrinin ərazilərində mühafizə olunan  
coğrafi göstəricilərin siyahısı**

**The list of geographical indications that are protected  
within the territory of the European Union countries.**

**Список географических указаний, охраняемых  
на территории стран Европейского Союза**

**Bülleten № 2. 28.02.2019**

Lucques du Languedoc		France	FR	FOOD	Class 1.6. Fruit, vegetables and cereals fresh or processed
Mâche nantaise		France	FR	FOOD	Class 1.6. Fruit, vegetables and cereals fresh or processed
Mâconnais		France	FR	FOOD	Class 1.3. Cheeses
Maine - Anjou		France	FR	FOOD	Class 1.1. Fresh meat (and offal)
Maroilles / Marolles		France	FR	FOOD	Class 1.3. Cheeses
Melon de Guadeloupe		France	FR	FOOD	Class 1.6. Fruit, vegetables and cereals fresh or processed
Melon du Haut-Poitou		France	FR	FOOD	Class 1.6. Fruit, vegetables and cereals fresh or processed
Melon du Quercy		France	FR	FOOD	Class 1.6. Fruit, vegetables and cereals fresh or processed
Miel d'Alsace		France	FR	FOOD	Class 1.4. Other products of animal origin (eggs, honey, various dairy products except butter, etc.)
Miel de Corse ; Mele di Corsica		France	FR	FOOD	Class 1.4. Other products of animal origin (eggs, honey, various dairy products except butter, etc.)
Miel de Provence		France	FR	FOOD	Class 1.4. Other products of animal origin (eggs, honey, various dairy products except butter, etc.)
Miel de sapin des Vosges		France	FR	FOOD	Class 1.4. Other products of animal origin (eggs, honey, various dairy products except butter, etc.)
Miel des Cévennes		France	FR	FOOD	Class 1.4. Other products of animal origin (eggs, honey, various dairy products except butter, etc.)
Mirabelles de Lorraine		France	FR	FOOD	Class 1.6. Fruit, vegetables and cereals fresh or processed
Moquette de Vendée		France	FR	FOOD	Class 1.6. Fruit, vegetables and cereals fresh or processed
Mont d'Or ; Vacherin du Haut-Doubs		France	FR	FOOD	Class 1.3. Cheeses
Morbier		France	FR	FOOD	Class 1.3. Cheeses
Moules de Bouchot de la Baie du Mont-Saint-Michel		France	FR	FOOD	Class 1.7. Fresh fish, molluscs, and crustaceans and products derived therefrom
Moutarde de Bourgogne		France	FR	FOOD	Class 2.6. Mustard paste
Munster ; Munster-Géromé		France	FR	FOOD	Class 1.3. Cheeses
Muscat du Ventoux		France	FR	FOOD	Class 1.6. Fruit, vegetables and cereals fresh or processed
Neufchâtel		France	FR	FOOD	Class 1.3. Cheeses
Noisette de Cervione — Nuciola di Cervioni		France	FR	FOOD	Class 1.6. Fruit, vegetables and cereals fresh or processed

**Avropa İttifaqı ölkələrinin ərazilərində mühafizə olunan  
coğrafi göstəricilərin siyahısı**

**The list of geographical indications that are protected  
within the territory of the European Union countries**

**Список географических указаний, охраняемых  
на территории стран Европейского Союза**

**Bülleten № 2. 28.02.2019**

Noix de Grenoble		France	FR	FOOD	Class 1.6. Fruit, vegetables and cereals fresh or processed
Noix du Périgord		France	FR	FOOD	Class 1.6. Fruit, vegetables and cereals fresh or processed
Œufs de Loué		France	FR	FOOD	Class 1.4. Other products of animal origin (eggs, honey, various dairy products except butter, etc.)
Oie d'Anjou		France	FR	FOOD	Class 1.1. Fresh meat (and offal)
Oignon de Roscoff		France	FR	FOOD	Class 1.6. Fruit, vegetables and cereals fresh or processed
Oignon doux des Cévennes		France	FR	FOOD	Class 1.6. Fruit, vegetables and cereals fresh or processed
Olive de Nice		France	FR	FOOD	Class 1.6. Fruit, vegetables and cereals fresh or processed
Olive de Nîmes		France	FR	FOOD	Class 1.6. Fruit, vegetables and cereals fresh or processed
Olives cassées de la Vallée des Baux de Provence		France	FR	FOOD	Class 1.6. Fruit, vegetables and cereals fresh or processed
Olives noires de la Vallée des Baux de Provence		France	FR	FOOD	Class 1.6. Fruit, vegetables and cereals fresh or processed
Olives noires de Nyons		France	FR	FOOD	Class 1.6. Fruit, vegetables and cereals fresh or processed
Ossau-Iraty		France	FR	FOOD	Class 1.3. Cheeses
Pâté de Campagne Breton		France	FR	FOOD	Class 1.2. Meat products (cooked, salted, smoked, etc.)
Pâtes d'Alsace		France	FR	FOOD	Class 2.7. Pasta
Pays d'Auge ; Pays d'Auge-Cambremer		France	FR	FOOD	Class 1.8. other products of Annex I of the Treaty (spices etc.)
Pélarдон		France	FR	FOOD	Class 1.3. Cheeses
Petit Épeautre de Haute Provence		France	FR	FOOD	Class 1.6. Fruit, vegetables and cereals fresh or processed
Picodon		France	FR	FOOD	Class 1.3. Cheeses
Piment d'Espelette ; Piment d'Espelette - Ezpeletako Biperra		France	FR	FOOD	Class 1.8. other products of Annex I of the Treaty (spices etc.)
Pintade de l'Ardèche		France	FR	FOOD	Class 1.1. Fresh meat (and offal)
Pintadeau de la Drôme		France	FR	FOOD	Class 1.1. Fresh meat (and offal)
Poireaux de Créances		France	FR	FOOD	Class 1.6. Fruit, vegetables and cereals fresh or processed
Pomelo de Corse		France	FR	FOOD	Class 1.6. Fruit, vegetables and cereals fresh or processed
Pomme de terre de l'Île de Ré		France	FR	FOOD	Class 1.6. Fruit, vegetables and cereals fresh or processed
Pomme du Limousin		France	FR	FOOD	Class 1.6. Fruit, vegetables and cereals fresh or processed

**Avropa İttifaqı ölkələrinin ərazilərində mühafizə olunan  
coğrafi göstəricilərin siyahısı**

**The list of geographical indications that are protected  
within the territory of the European Union countries.**

**Список географических указаний, охраняемых  
на территории стран Европейского Союза**

**Bülleten № 2. 28.02.2019**

Pommes de terre de Merville		France	FR	FOOD	Class 1.6. Fruit, vegetables and cereals fresh or processed
Pommes des Alpes de Haute Durance		France	FR	FOOD	Class 1.6. Fruit, vegetables and cereals fresh or processed
Pommes et Poires de Savoie/Pommes de Savoie/Poires de Savoie		France	FR	FOOD	Class 1.6. Fruit, vegetables and cereals fresh or processed
Pont-l'Évêque		France	FR	FOOD	Class 1.3. Cheeses
Porc d'Auvergne		France	FR	FOOD	Class 1.1. Fresh meat (and offal)
Porc de Franche-Comté		France	FR	FOOD	Class 1.1. Fresh meat (and offal)
Porc de Vendée		France	FR	FOOD	Class 1.1. Fresh meat (and offal)
Porc du Limousin		France	FR	FOOD	Class 1.1. Fresh meat (and offal)
Porc du Sud-Ouest		France	FR	FOOD	Class 1.1. Fresh meat (and offal)
Porc noir de Bigorre		France	FR	FOOD	Class 1.1. Fresh meat (and offal)
Poularde du Périgord		France	FR	FOOD	Class 1.1. Fresh meat (and offal)
Poulet de l'Ardèche/Chapon de l'Ardèche		France	FR	FOOD	Class 1.1. Fresh meat (and offal)
Poulet des Cévennes / Chapon des Cévennes		France	FR	FOOD	Class 1.1. Fresh meat (and offal)
Poulet du Périgord		France	FR	FOOD	Class 1.1. Fresh meat (and offal)
Pouligny-Saint-Pierre		France	FR	FOOD	Class 1.3. Cheeses
Prés-salés de la baie de Somme		France	FR	FOOD	Class 1.1. Fresh meat (and offal)
Prés-salés du Mont-Saint-Michel		France	FR	FOOD	Class 1.1. Fresh meat (and offal)
Pruneaux d'Agen ; Pruneaux d'Agen mi-cuits		France	FR	FOOD	Class 1.6. Fruit, vegetables and cereals fresh or processed
Raclette de Savoie		France	FR	FOOD	Class 1.3. Cheeses
Raviole du Dauphiné		France	FR	FOOD	Class 2.7. Pasta
Reblochon / Reblochon de Savoie		France	FR	FOOD	Class 1.3. Cheeses
Rigotte de Condrieu		France	FR	FOOD	Class 1.3. Cheeses
Rillettes de Tours		France	FR	FOOD	Class 1.2. Meat products (cooked, salted, smoked, etc.)
Riz de Camargue		France	FR	FOOD	Class 1.6. Fruit, vegetables and cereals fresh or processed
Rocamadour		France	FR	FOOD	Class 1.3. Cheeses
Roquefort		France	FR	FOOD	Class 1.3. Cheeses
Sainte-Maure de Touraine		France	FR	FOOD	Class 1.3. Cheeses
Saint-Marcellin		France	FR	FOOD	Class 1.3. Cheeses
Saint-Nectaire		France	FR	FOOD	Class 1.3. Cheeses

**Avropa İttifaqı ölkələrinin ərazilərində mühafizə olunan  
coğrafi göstəricilərin siyahısı**

**The list of geographical indications that are protected  
within the territory of the European Union countries**

**Список географических указаний, охраняемых  
на территории стран Европейского Союза**

**Bülleten № 2. 28.02.2019**

Salers		France	FR	FOOD	Class 1.3. Cheeses
Saucisse de Montbéliard		France	FR	FOOD	Class 1.2. Meat products (cooked, salted, smoked, etc.)
Saucisse de Morteau / Jésus de Morteau		France	FR	FOOD	Class 1.2. Meat products (cooked, salted, smoked, etc.)
Saucisson de Lacaune / Saucisse de Lacaune		France	FR	FOOD	Class 1.2. Meat products (cooked, salted, smoked, etc.)
Saucisson de l'Ardèche		France	FR	FOOD	Class 1.2. Meat products (cooked, salted, smoked, etc.)
Saucisson sec d'Auvergne / Saucisse sèche d'Auvergne		France	FR	FOOD	Class 1.2. Meat products (cooked, salted, smoked, etc.)
Sel de Guérande / Fleur de sel de Guérande		France	FR	FOOD	Class 1.8. other products of Annex I of the Treaty (spices etc.)
Sel de Salies-de-Béarn		France	FR	FOOD	Class 1.8. other products of Annex I of the Treaty (spices etc.)
Selles-sur-Cher		France	FR	FOOD	Class 1.3. Cheeses
Soumaintrain		France	FR	FOOD	Class 1.3. Cheeses
Taureau de Camargue		France	FR	FOOD	Class 1.1. Fresh meat (and offal)
Thym de Provence		France	FR	FOOD	Class 1.8. other products of Annex I of the Treaty (spices etc.)
Tome des Bauges		France	FR	FOOD	Class 1.3. Cheeses
Tomme de Savoie		France	FR	FOOD	Class 1.3. Cheeses
Tomme des Pyrénées		France	FR	FOOD	Class 1.3. Cheeses
Valençay		France	FR	FOOD	Class 1.3. Cheeses
Veau d'Aveyron et du Ségala		France	FR	FOOD	Class 1.1. Fresh meat (and offal)
Veau du Limousin		France	FR	FOOD	Class 1.1. Fresh meat (and offal)
Volaille de Bresse/Poulet de Bresse/Poularde de Bresse/Chapon de Bresse		France	FR	FOOD	Class 1.1. Fresh meat (and offal)
Volailles d'Alsace		France	FR	FOOD	Class 1.1. Fresh meat (and offal)
Volailles d'Ancenis		France	FR	FOOD	Class 1.1. Fresh meat (and offal)
Volailles d'Auvergne		France	FR	FOOD	Class 1.1. Fresh meat (and offal)
Volailles de Bourgogne		France	FR	FOOD	Class 1.1. Fresh meat (and offal)
Volailles de Bretagne		France	FR	FOOD	Class 1.1. Fresh meat (and offal)
Volailles de Challans		France	FR	FOOD	Class 1.1. Fresh meat (and offal)
Volailles de Cholet		France	FR	FOOD	Class 1.1. Fresh meat (and offal)



**Avropa İttifaqı ölkələrinin ərazilərində mühafizə olunan  
coğrafi göstəricilərin siyahısı**

**The list of geographical indications that are protected  
within the territory of the European Union countries.**

**Список географических указаний, охраняемых  
на территории стран Европейского Союза**

**Bülleten № 2. 28.02.2019**

Volailles de Gascogne		France	FR	FOOD	Class 1.1. Fresh meat (and offal)
Volailles de Houdan		France	FR	FOOD	Class 1.1. Fresh meat (and offal)
Volailles de Janzé		France	FR	FOOD	Class 1.1. Fresh meat (and offal)
Volailles de la Champagne		France	FR	FOOD	Class 1.1. Fresh meat (and offal)
Volailles de la Drôme		France	FR	FOOD	Class 1.1. Fresh meat (and offal)
Volailles de l'Ain		France	FR	FOOD	Class 1.1. Fresh meat (and offal)
Volailles de Licques		France	FR	FOOD	Class 1.1. Fresh meat (and offal)
Volailles de l'Orléanais		France	FR	FOOD	Class 1.1. Fresh meat (and offal)
Volailles de Loué		France	FR	FOOD	Class 1.1. Fresh meat (and offal)
Volailles de Normandie		France	FR	FOOD	Class 1.1. Fresh meat (and offal)
Volailles des Landes		France	FR	FOOD	Class 1.1. Fresh meat (and offal)
Volailles du Béarn		France	FR	FOOD	Class 1.1. Fresh meat (and offal)
Volailles du Berry		France	FR	FOOD	Class 1.1. Fresh meat (and offal)
Volailles du Charolais		France	FR	FOOD	Class 1.1. Fresh meat (and offal)
Volailles du Forez		France	FR	FOOD	Class 1.1. Fresh meat (and offal)
Volailles du Gatinais		France	FR	FOOD	Class 1.1. Fresh meat (and offal)
Volailles du Gers		France	FR	FOOD	Class 1.1. Fresh meat (and offal)
Volailles du Languedoc		France	FR	FOOD	Class 1.1. Fresh meat (and offal)
Volailles du Lauragais		France	FR	FOOD	Class 1.1. Fresh meat (and offal)
Volailles du Maine		France	FR	FOOD	Class 1.1. Fresh meat (and offal)
Volailles du plateau de Langres		France	FR	FOOD	Class 1.1. Fresh meat (and offal)
Volailles du Val de Sèvres		France	FR	FOOD	Class 1.1. Fresh meat (and offal)
Volailles du Velay		France	FR	FOOD	Class 1.1. Fresh meat (and offal)
Armagnac (The denomination 'Armagnac' may be supplemented by the following terms: — Bas-Armagnac — Haut-Armagnac —		France	FR	SPIRITS	Wine spirit

**Avropa İttifaqı ölkələrinin ərazilərində mühafizə olunan  
coğrafi göstəricilərin siyahısı**

**The list of geographical indications that are protected  
within the territory of the European Union countries**

**Список географических указаний, охраняемых  
на территории стран Европейского Союза**

**Bülleten № 2. 28.02.2019**

Armagnac-Ténarèze — Blanche Armagnac)					
Calvados		France	FR	SPIRITS	Cider spirit and perry spirit
Calvados Domfrontais		France	FR	SPIRITS	Cider spirit and perry spirit
Calvados Pays d'Auge		France	FR	SPIRITS	Cider spirit and perry spirit
Cassis de Bourgogne		France	FR	SPIRITS	Crème de cassis
Cassis de Dijon		France	FR	SPIRITS	Crème de cassis
Cassis de Saintonge		France	FR	SPIRITS	Crème de cassis
Cognac (The denomination 'Cognac' may be supplemented by the following terms: Fine / Grande Fine Champagne / Grande Champagne / Petite Fine Champagne / Petite Champagne / Fine Champagne / Borderies / Fins Bois / Bons Bois)		France	FR	SPIRITS	Wine spirit
Eau-de-vie de cidre de Bretagne		France	FR	SPIRITS	Cider spirit and perry spirit
Eau-de-vie de cidre de Normandie		France	FR	SPIRITS	Cider spirit and perry spirit
Eau-de-vie de cidre du Maine		France	FR	SPIRITS	Cider spirit and perry spirit
Eau-de-vie de Cognac		France	FR	SPIRITS	Wine spirit
Eau-de-vie de Faugères/Faugères		France	FR	SPIRITS	Wine spirit
Eau-de-vie de poiré de Normandie		France	FR	SPIRITS	Cider spirit and perry spirit
Eau-de-vie de vin de la Marne		France	FR	SPIRITS	Wine spirit
Eau-de-vie de vin des Côtes-du-Rhône		France	FR	SPIRITS	Wine spirit
Eau-de-vie de vin originaire du Bugey		France	FR	SPIRITS	Wine spirit
Eau-de-vie de vin originaire du Languedoc		France	FR	SPIRITS	Wine spirit
Eau-de-vie des Charentes		France	FR	SPIRITS	Wine spirit
Fine Bordeaux		France	FR	SPIRITS	Wine spirit
Fine de Bourgogne		France	FR	SPIRITS	Wine spirit
Framboise d'Alsace		France	FR	SPIRITS	Fruit spirit
Genièvre Flandres Artois		France	FR	SPIRITS	Juniper-flavoured spirit drinks
Kirsch d'Alsace		France	FR	SPIRITS	Fruit spirit
Kirsch de Fougerolles		France	FR	SPIRITS	Fruit spirit
Marc d'Alsace Gewürztraminer		France	FR	SPIRITS	Grape marc spirit or grape marc
Marc d'Auvergne		France	FR	SPIRITS	Grape marc spirit or grape marc

**Avropa İttifaqı ölkələrinin ərazilərində mühafizə olunan  
coğrafi göstəricilərin siyahısı**

**The list of geographical indications that are protected  
within the territory of the European Union countries.**

**Список географических указаний, охраняемых  
на территории стран Европейского Союза**

**Bülleten № 2. 28.02.2019**

Marc de Bourgogne/Eau-de-vie de marc de Bourgogne		France	FR	SPIRITS	Grape marc spirit or grape marc
Marc de Champagne/Eau-de-vie de marc de Champagne		France	FR	SPIRITS	Grape marc spirit or grape marc
Marc de Provence/Eau-de-vie de marc originaire de Provence		France	FR	SPIRITS	Grape marc spirit or grape marc
Marc de Savoie/Eau-de-vie de marc originaire de Savoie		France	FR	SPIRITS	Grape marc spirit or grape marc
Marc des Côtes-du-Rhône/Eau-de-vie de marc des Côtes du Rhône		France	FR	SPIRITS	Grape marc spirit or grape marc
Marc du Bugey/Eau-de-vie de marc originaire de Bugey		France	FR	SPIRITS	Grape marc spirit or grape marc
Marc du Jura		France	FR	SPIRITS	Grape marc spirit or grape marc
Marc du Languedoc/Eau-de-vie de marc originaire du Languedoc		France	FR	SPIRITS	Grape marc spirit or grape marc
Mirabelle d'Alsace		France	FR	SPIRITS	Fruit spirit
Mirabelle de Lorraine		France	FR	SPIRITS	Fruit spirit
Pommeau de Bretagne		France	FR	SPIRITS	Other
Pommeau de Normandie		France	FR	SPIRITS	Other
Pommeau du Maine		France	FR	SPIRITS	Other
Quetsch d'Alsace		France	FR	SPIRITS	Fruit spirit
Ratafia de Champagne		France	FR	SPIRITS	Liqueur
Rhum de la Guadeloupe		France	FR	SPIRITS	Rum
Rhum de la Guyane		France	FR	SPIRITS	Rum
Rhum de la Martinique		France	FR	SPIRITS	Rum
Rhum de la Réunion		France	FR	SPIRITS	Rum
Rhum de sucrerie de la Baie du Galion		France	FR	SPIRITS	Rum
Rhum des Antilles françaises		France	FR	SPIRITS	Rum
Rhum des départements français d'outre-mer		France	FR	SPIRITS	Rum
Whisky alsacien/Whisky d'Alsace		France	FR	SPIRITS	Whisky or Whiskey

**Avropa İttifaqı ölkələrinin ərazilərində mühafizə olunan  
coğrafi göstəricilərin siyahısı**

**The list of geographical indications that are protected  
within the territory of the European Union countries**

**Список географических указаний, охраняемых  
на территории стран Европейского Союза**

**Bülleten № 2. 28.02.2019**

Whisky breton/Whisky de Bretagne		France	FR	SPIRITS	Whisky or Whiskey
Agenais		France	FR	WINE	
Ain		France	FR	WINE	
Ajaccio		France	FR	WINE	
Allobrogie		France	FR	WINE	
Aloxe-Corton		France	FR	WINE	
Alpes-de-Haute-Provence		France	FR	WINE	
Alpes-Maritimes		France	FR	WINE	
Apilles		France	FR	WINE	
Alsace		France	FR	WINE	
Alsace grand cru Altenberg de Bergbieten		France	FR	WINE	
Alsace grand cru Altenberg de Bergheim		France	FR	WINE	
Alsace grand cru Altenberg de Wolxheim		France	FR	WINE	
Alsace grand cru Brand		France	FR	WINE	
Alsace grand cru Bruderthal		France	FR	WINE	
Alsace grand cru Eichberg		France	FR	WINE	
Alsace grand cru Engelberg		France	FR	WINE	
Alsace grand cru Florimont		France	FR	WINE	
Alsace grand cru Frankstein		France	FR	WINE	
Alsace grand cru Froehn		France	FR	WINE	
Alsace grand cru Furstentum		France	FR	WINE	
Alsace grand cru Geisberg		France	FR	WINE	
Alsace grand cru Gloeckelberg		France	FR	WINE	
Alsace grand cru Goldert		France	FR	WINE	
Alsace grand cru Hatschbourg		France	FR	WINE	
Alsace grand cru Hengst		France	FR	WINE	
Alsace grand cru Kaefferkopf		France	FR	WINE	
Alsace grand cru Kanzlerberg		France	FR	WINE	
Alsace grand cru Kastelberg		France	FR	WINE	

**Avropa İttifaqı ölkələrinin ərazilərində mühafizə olunan  
coğrafi göstəricilərin siyahısı**

**The list of geographical indications that are protected  
within the territory of the European Union countries.**

**Список географических указаний, охраняемых  
на территории стран Европейского Союза**

Bülleten № 2. 28.02.2019

Alsace grand cru Kessler		France	FR	WINE	
Alsace grand cru Kirchberg de Barr		France	FR	WINE	
Alsace grand cru Kirchberg de Ribeauvillé		France	FR	WINE	
Alsace grand cru Kitterlé		France	FR	WINE	
Alsace grand cru Mambourg		France	FR	WINE	
Alsace grand cru Mandelberg		France	FR	WINE	
Alsace grand cru Marckrain		France	FR	WINE	
Alsace grand cru Moenchberg		France	FR	WINE	
Alsace grand cru Muenchberg		France	FR	WINE	
Alsace grand cru Ollwiller		France	FR	WINE	
Alsace grand cru Osterberg		France	FR	WINE	
Alsace grand cru Pfersigberg		France	FR	WINE	
Alsace grand cru Pfingstberg		France	FR	WINE	
Alsace grand cru Praelatenberg		France	FR	WINE	
Alsace grand cru Rangen		France	FR	WINE	
Alsace grand cru Rosacker		France	FR	WINE	
Alsace grand cru Saering		France	FR	WINE	
Alsace grand cru Schlossberg		France	FR	WINE	
Alsace grand cru Schoenenbourg		France	FR	WINE	
Alsace grand cru Sommerberg		France	FR	WINE	
Alsace grand cru Sonnenglanz		France	FR	WINE	
Alsace grand cru Spiegel		France	FR	WINE	
Alsace grand cru Sporen		France	FR	WINE	
Alsace grand cru Steinert		France	FR	WINE	
Alsace grand cru Steingrubler		France	FR	WINE	
Alsace grand cru Steinklotz		France	FR	WINE	



**Avropa İttifaqı ölkələrinin ərazilərində mühafizə olunan  
coğrafi göstəricilərin siyahısı**

**The list of geographical indications that are protected  
within the territory of the European Union countries**

**Список географических указаний, охраняемых  
на территории стран Европейского Союза**

**Bülleten № 2. 28.02.2019**

Alsace grand cru Vorbourg		France	FR	WINE	
Alsace grand cru Wiebelsberg		France	FR	WINE	
Alsace grand cru Wineck-Schlossberg		France	FR	WINE	
Alsace grand cru Winzenberg		France	FR	WINE	
Alsace grand cru Zinnkoepflé		France	FR	WINE	
Alsace grand cru Zotzenberg		France	FR	WINE	
Anjou		France	FR	WINE	
Anjou Villages		France	FR	WINE	
Anjou Villages Brissac		France	FR	WINE	
Anjou-Coteaux de la Loire		France	FR	WINE	
Arbois		France	FR	WINE	
Ardèche		France	FR	WINE	
Ariège		France	FR	WINE	
Atlantique		France	FR	WINE	
Aude		France	FR	WINE	
Auxey-Duresses		France	FR	WINE	
Aveyron		France	FR	WINE	
Bandol		France	FR	WINE	
Banyuls		France	FR	WINE	
Banyuls grand cru		France	FR	WINE	
Barsac		France	FR	WINE	
Bâtard-Montrachet		France	FR	WINE	
Béarn		France	FR	WINE	
Beaujolais		France	FR	WINE	
Beaumes de Venise		France	FR	WINE	
Beaune		France	FR	WINE	
Bellet		France	FR	WINE	
Bergerac		France	FR	WINE	
Bienvenues-Bâtard- Montrachet		France	FR	WINE	
Blagny		France	FR	WINE	
Blanc Fumé de Pouilly		France	FR	WINE	
Blaye		France	FR	WINE	
Bonnes-Mares		France	FR	WINE	
Bonnezeaux		France	FR	WINE	
Bordeaux		France	FR	WINE	
Bordeaux supérieur		France	FR	WINE	
Bouches-du-Rhône		France	FR	WINE	
Bourg		France	FR	WINE	
Bourgeais		France	FR	WINE	
Bourgogne		France	FR	WINE	
Bourgogne aligoté		France	FR	WINE	
Bourgogne grand ordinaire		France	FR	WINE	
Bourgogne mousseux		France	FR	WINE	

**Avropa İttifaqı ölkələrinin ərazilərində mühafizə olunan  
coğrafi göstəricilərin siyahısı**

**The list of geographical indications that are protected  
within the territory of the European Union countries.**

**Список географических указаний, охраняемых  
на территории стран Европейского Союза**

Bülleten № 2. 28.02.2019

Bourgogne ordinaire		France	FR	WINE	
Bourgogne Passe-tout-grains		France	FR	WINE	
Bourgueil		France	FR	WINE	
Bouzeron		France	FR	WINE	
Brouilly		France	FR	WINE	
Brulhois		France	FR	WINE	
Bugey		France	FR	WINE	
Buzet		France	FR	WINE	
Cabardès		France	FR	WINE	
Cabernet d'Anjou		France	FR	WINE	
Cabernet de Saumur		France	FR	WINE	
Cadillac		France	FR	WINE	
Cahors		France	FR	WINE	
Calvados		France	FR	WINE	
Canon Fronsac		France	FR	WINE	
Cassis		France	FR	WINE	
Cathare		France	FR	WINE	
Cérons		France	FR	WINE	
Cévennes		France	FR	WINE	
Chablis		France	FR	WINE	
Chablis grand cru		France	FR	WINE	
Chambertin		France	FR	WINE	
Chambertin-Clos de Bèze		France	FR	WINE	
Chambolle-Musigny		France	FR	WINE	
Champagne		France	FR	WINE	
Chapelle-Chambertin		France	FR	WINE	
Charentais		France	FR	WINE	
Charlemagne		France	FR	WINE	
Charmes-Chambertin		France	FR	WINE	
Chassagne-Montrachet		France	FR	WINE	
Château-Chalon		France	FR	WINE	
Château-Grillet		France	FR	WINE	
Châteaumeillant		France	FR	WINE	
Châteauneuf-du-Pape		France	FR	WINE	
Châtillon-en-Diois		France	FR	WINE	
Chénas		France	FR	WINE	
Chevalier-Montrachet		France	FR	WINE	
Cheverny		France	FR	WINE	
Chinon		France	FR	WINE	
Chiroubles		France	FR	WINE	
Chorey-lès-Beaune		France	FR	WINE	
Cité de Carcassonne		France	FR	WINE	
Clairette de Bellegarde		France	FR	WINE	
Clairette de Die		France	FR	WINE	
Clairette du Languedoc		France	FR	WINE	
Clos de la Roche		France	FR	WINE	
Clos de Tart		France	FR	WINE	
Clos de Vougeot		France	FR	WINE	

**Avropa İttifaqı ölkələrinin ərazilərində mühafizə olunan  
coğrafi göstəricilərin siyahısı**

**The list of geographical indications that are protected  
within the territory of the European Union countries**

**Список географических указаний, охраняемых  
на территории стран Европейского Союза**

**Bülleten № 2. 28.02.2019**

Clos des Lambrays		France	FR	WINE	
Clos Saint-Denis		France	FR	WINE	
Clos Vougeot		France	FR	WINE	
Collines Rhodaniennes		France	FR	WINE	
Collioure		France	FR	WINE	
Comté Tolosan		France	FR	WINE	
Comtés Rhodaniens		France	FR	WINE	
Condrieu		France	FR	WINE	
Corbières		France	FR	WINE	
Corbières-Boutenac		France	FR	WINE	
Cornas		France	FR	WINE	
Corrèze		France	FR	WINE	
Corse		France	FR	WINE	
Corton		France	FR	WINE	
Corton-Charlemagne		France	FR	WINE	
Costières de Nîmes		France	FR	WINE	
Côte de Beaune		France	FR	WINE	
Côte de Beaune- Villages		France	FR	WINE	
Côte de Brouilly		France	FR	WINE	
Côte de Nuits-Villages		France	FR	WINE	
Côte Roannaise		France	FR	WINE	
Côte Rôtie		France	FR	WINE	
Côte Vermeille		France	FR	WINE	
Coteaux Bourguignons		France	FR	WINE	
Coteaux champenois		France	FR	WINE	
Coteaux Charitois		France	FR	WINE	
Coteaux d'Ensérune		France	FR	WINE	
Coteaux d'Aix-en- Provence		France	FR	WINE	
Coteaux d'Ancenis		France	FR	WINE	
Coteaux de Coiffy		France	FR	WINE	
Coteaux de Die		France	FR	WINE	
Coteaux de Glanes		France	FR	WINE	
Coteaux de l'Auxois		France	FR	WINE	
Coteaux de l'Aubance		France	FR	WINE	
Coteaux de Narbonne		France	FR	WINE	
Coteaux de Peyriac		France	FR	WINE	
Coteaux de Saumur		France	FR	WINE	
Coteaux de Tannay		France	FR	WINE	
Coteaux des Baronnies		France	FR	WINE	
Coteaux du Cher et de l'Arnon		France	FR	WINE	
Coteaux du Giennois		France	FR	WINE	
Coteaux du Languedoc		France	FR	WINE	
Coteaux du Layon		France	FR	WINE	
Coteaux du Libron		France	FR	WINE	
Coteaux du Loir		France	FR	WINE	
Coteaux du Lyonnais		France	FR	WINE	

**Avropa İttifaqı ölkələrinin ərazilərində mühafizə olunan  
coğrafi göstəricilərin siyahısı**

**The list of geographical indications that are protected  
within the territory of the European Union countries.**

**Список географических указаний, охраняемых  
на территории стран Европейского Союза**

Bülleten № 2. 28.02.2019

Coteaux du Pont du Gard		France	FR	WINE	
Coteaux du Quercy		France	FR	WINE	
Coteaux du Vendômois		France	FR	WINE	
Coteaux Varois en Provence		France	FR	WINE	
Côtes Catalanes		France	FR	WINE	
Côtes d'Auvergne		France	FR	WINE	
Côtes de Bergerac		France	FR	WINE	
Côtes de Blaye		France	FR	WINE	
Côtes de Bordeaux		France	FR	WINE	
Côtes de Bordeaux-Saint-Macaire		France	FR	WINE	
Côtes de Bourg		France	FR	WINE	
Côtes de Duras		France	FR	WINE	
Côtes de Gascogne		France	FR	WINE	
Côtes de Meuse		France	FR	WINE	
Côtes de Millau		France	FR	WINE	
Côtes de Montravel		France	FR	WINE	
Côtes de Provence		France	FR	WINE	
Côtes de Thau		France	FR	WINE	
Côtes de Thongue		France	FR	WINE	
Côtes de Toul		France	FR	WINE	
Côtes du Forez		France	FR	WINE	
Côtes du Jura		France	FR	WINE	
Côtes du Marmandais		France	FR	WINE	
Côtes du Rhône		France	FR	WINE	
Côtes du Rhône Villages		France	FR	WINE	
Côtes du Roussillon		France	FR	WINE	
Côtes du Roussillon Villages		France	FR	WINE	
Côtes du Tarn		France	FR	WINE	
Côtes du Vivarais		France	FR	WINE	
Cour-Cheverny		France	FR	WINE	
Crémant d'Alsace		France	FR	WINE	
Crémant de Bordeaux		France	FR	WINE	
Crémant de Bourgogne		France	FR	WINE	
Crémant de Die		France	FR	WINE	
Crémant de Limoux		France	FR	WINE	
Crémant de Loire		France	FR	WINE	
Crémant du Jura		France	FR	WINE	
Criots-Bâtard-Montrachet		France	FR	WINE	
Crozes-Ermitage		France	FR	WINE	
Crozes-Hermitage		France	FR	WINE	
Drôme		France	FR	WINE	
Duché d'Uzès		France	FR	WINE	
Echezeaux		France	FR	WINE	
Entraygues - Le Fel		France	FR	WINE	

**Avropa İttifaqı ölkələrinin ərazilərində mühafizə olunan  
coğrafi göstəricilərin siyahısı**

**The list of geographical indications that are protected  
within the territory of the European Union countries**

**Список географических указаний, охраняемых  
на территории стран Европейского Союза**

**Bülleten № 2. 28.02.2019**

Entre-deux-Mers		France	FR	WINE	
Ermitage		France	FR	WINE	
Estaing		France	FR	WINE	
Faugères		France	FR	WINE	
Fiefs Vendéens		France	FR	WINE	
Fitou		France	FR	WINE	
Fixin		France	FR	WINE	
Fleurie		France	FR	WINE	
Floc de Gascogne		France	FR	WINE	
Franche-Comté		France	FR	WINE	
Fronsac		France	FR	WINE	
Frontignan		France	FR	WINE	
Fronton		France	FR	WINE	
Gaillac		France	FR	WINE	
Gaillac premières côtes		France	FR	WINE	
Gard		France	FR	WINE	
Gers		France	FR	WINE	
Gevrey-Chambertin		France	FR	WINE	
Gigondas		France	FR	WINE	
Givry		France	FR	WINE	
Grand Roussillon		France	FR	WINE	
Grands-Echezeaux		France	FR	WINE	
Graves		France	FR	WINE	
Graves de Vayres		France	FR	WINE	
Graves supérieures		France	FR	WINE	
Grignan-les-Adhémar		France	FR	WINE	
Griotte-Chambertin		France	FR	WINE	
Gros Plant du Pays nantais		France	FR	WINE	
Haute Vallée de l'Aude		France	FR	WINE	
Haute Vallée de l'Orb		France	FR	WINE	
Haute-Marne		France	FR	WINE	
Hautes-Alpes		France	FR	WINE	
Haute-Vienne		France	FR	WINE	
Haut-Médoc		France	FR	WINE	
Haut-Montravel		France	FR	WINE	
Haut-Poitou		France	FR	WINE	
Hermitage		France	FR	WINE	
Île de Beauté		France	FR	WINE	
Irancy		France	FR	WINE	
Irouléguay		France	FR	WINE	
Isère		France	FR	WINE	
Jasnières		France	FR	WINE	
Juliénaş		France	FR	WINE	
Jurançon		France	FR	WINE	
La Clape		France	FR	WINE	
La Grande Rue		France	FR	WINE	
La Romanée		France	FR	WINE	
La Tâche		France	FR	WINE	
Ladoix		France	FR	WINE	



**Avropa İttifaqı ölkələrinin ərazilərində mühafizə olunan  
coğrafi göstəricilərin siyahısı**

**The list of geographical indications that are protected  
within the territory of the European Union countries.**

**Список географических указаний, охраняемых  
на территории стран Европейского Союза**

Bülleten № 2. 28.02.2019

Lalande-de-Pomerol		France	FR	WINE	
Landes		France	FR	WINE	
Languedoc		France	FR	WINE	
Latricières-Chambertin		France	FR	WINE	
Lavilledieu		France	FR	WINE	
L'Ermitage		France	FR	WINE	
Les Baux de Provence		France	FR	WINE	
L'Etoile		France	FR	WINE	
L'Hermitage		France	FR	WINE	
Limoux		France	FR	WINE	
Lirac		France	FR	WINE	
Listrac-Médoc		France	FR	WINE	
Lot		France	FR	WINE	
Loupiac		France	FR	WINE	
Luberon		France	FR	WINE	
Lussac Saint-Emilion		France	FR	WINE	
Mâcon		France	FR	WINE	
Macvin du Jura		France	FR	WINE	
Madiran		France	FR	WINE	
Malepère		France	FR	WINE	
Maranges		France	FR	WINE	
Marcillac		France	FR	WINE	
Margaux		France	FR	WINE	
Marsannay		France	FR	WINE	
Maures		France	FR	WINE	
Maury		France	FR	WINE	
Mazis-Chambertin		France	FR	WINE	
Mazoyères- Chambertin		France	FR	WINE	
Méditerranée		France	FR	WINE	
Médoc		France	FR	WINE	
Menetou-Salon		France	FR	WINE	
Mercurey		France	FR	WINE	
Meursault		France	FR	WINE	
Minervois		France	FR	WINE	
Minervois-la-Livinière		France	FR	WINE	
Monbazillac		France	FR	WINE	
Mont Caume		France	FR	WINE	
Montagne-Saint- Emilion		France	FR	WINE	
Montagny		France	FR	WINE	
Monthélie		France	FR	WINE	
Montlouis-sur-Loire		France	FR	WINE	
Montrachet		France	FR	WINE	
Montravel		France	FR	WINE	
Morey-Saint-Denis		France	FR	WINE	
Morgon		France	FR	WINE	
Moselle		France	FR	WINE	
Moulin-à-Vent		France	FR	WINE	
Moulis		France	FR	WINE	
Moulis-en-Médoc		France	FR	WINE	
Muscadet		France	FR	WINE	

**Avropa İttifaqı ölkələrinin ərazilərində mühafizə olunan  
coğrafi göstəricilərin siyahısı**

**The list of geographical indications that are protected  
within the territory of the European Union countries**

**Список географических указаний, охраняемых  
на территории стран Европейского Союза**

**Bülleten № 2. 28.02.2019**

Muscadet Coteaux de la Loire		France	FR	WINE	
Muscadet Côtes de Grandlieu		France	FR	WINE	
Muscadet Sèvre et Maine		France	FR	WINE	
Muscat de Beaumes-de-Venise		France	FR	WINE	
Muscat de Frontignan		France	FR	WINE	
Muscat de Lunel		France	FR	WINE	
Muscat de Mireval		France	FR	WINE	
Muscat de Rivesaltes		France	FR	WINE	
Muscat de Saint-Jean-de-Minervois		France	FR	WINE	
Muscat du Cap Corse		France	FR	WINE	
Musigny		France	FR	WINE	
Nuits-Saint-Georges		France	FR	WINE	
Orléans		France	FR	WINE	
Orléans-Cléry		France	FR	WINE	
Pacherenc du Vic-Bilh		France	FR	WINE	
Palette		France	FR	WINE	
Patrimonio		France	FR	WINE	
Pauillac		France	FR	WINE	
Pays d'Hérault		France	FR	WINE	
Pays d'Oc		France	FR	WINE	
Pécharmant		France	FR	WINE	
Périgord		France	FR	WINE	
Pernand-Vergelesses		France	FR	WINE	
Pessac-Léognan		France	FR	WINE	
Petit Chablis		France	FR	WINE	
Picpoul de Pinet		France	FR	WINE	
Pierrevert		France	FR	WINE	
Pineau des Charentes		France	FR	WINE	
Pomerol		France	FR	WINE	
Pommard		France	FR	WINE	
Pouilly-Fuissé		France	FR	WINE	
Pouilly-Fumé		France	FR	WINE	
Pouilly-Loché		France	FR	WINE	
Pouilly-sur-Loire		France	FR	WINE	
Pouilly-Vinzelles		France	FR	WINE	
Premières Côtes de Bordeaux		France	FR	WINE	
Puy-de-Dôme		France	FR	WINE	
Quarts de Chaume		France	FR	WINE	
Quincy		France	FR	WINE	
Rasteau		France	FR	WINE	
Régnié		France	FR	WINE	
Reuilly		France	FR	WINE	
Richebourg		France	FR	WINE	
Rivesaltes		France	FR	WINE	
Romanée-Conti		France	FR	WINE	
Romanée-Saint-Vivant		France	FR	WINE	

**Avropa İttifaqı ölkələrinin ərazilərində mühafizə olunan  
coğrafi göstəricilərin siyahısı**

**The list of geographical indications that are protected  
within the territory of the European Union countries.**

**Список географических указаний, охраняемых  
на территории стран Европейского Союза**

Bülleten № 2. 28.02.2019

Rosé d'Anjou		France	FR	WINE	
Rosé de Loire		France	FR	WINE	
Rosé des Riceys		France	FR	WINE	
Rosette		France	FR	WINE	
Roussette de Savoie		France	FR	WINE	
Roussette du Bugey		France	FR	WINE	
Ruchottes-Chambertin		France	FR	WINE	
Rully		France	FR	WINE	
Sables du Golfe du Lion		France	FR	WINE	
Saint-Amour		France	FR	WINE	
Saint-Aubin		France	FR	WINE	
Saint-Bris		France	FR	WINE	
Saint-Chinian		France	FR	WINE	
Sainte-Croix-du-Mont		France	FR	WINE	
Sainte-Foy-Bordeaux		France	FR	WINE	
Sainte-Marie-la-Blanche		France	FR	WINE	
Saint-Emilion		France	FR	WINE	
Saint-Emilion Grand Cru		France	FR	WINE	
Saint-Estèphe		France	FR	WINE	
Saint-Georges-Saint-Emilion		France	FR	WINE	
Saint-Guilhem-le-Désert		France	FR	WINE	
Saint-Joseph		France	FR	WINE	
Saint-Julien		France	FR	WINE	
Saint-Mont		France	FR	WINE	
Saint-Nicolas-de-Bourgueil		France	FR	WINE	
Saint-Péray		France	FR	WINE	
Saint-Pourçain		France	FR	WINE	
Saint-Romain		France	FR	WINE	
Saint-Sardos		France	FR	WINE	
Saint-Véran		France	FR	WINE	
Sancerre		France	FR	WINE	
Santenay		France	FR	WINE	
Saône-et-Loire		France	FR	WINE	
Saumur		France	FR	WINE	
Saumur-Champigny		France	FR	WINE	
Saussignac		France	FR	WINE	
Sauternes		France	FR	WINE	
Savennières		France	FR	WINE	
Savennières Coulée de Serrant		France	FR	WINE	
Savennières Roche aux Moines		France	FR	WINE	
Savigny-lès-Beaune		France	FR	WINE	
Savoie		France	FR	WINE	
Seysssel		France	FR	WINE	
Tavel		France	FR	WINE	

**Avropa İttifaqı ölkələrinin ərazilərində mühafizə olunan  
coğrafi göstəricilərin siyahısı**

**The list of geographical indications that are protected  
within the territory of the European Union countries**

**Список географических указаний, охраняемых  
на территории стран Европейского Союза**

**Bülleten № 2. 28.02.2019**

Terrasses du Larzac		France	FR	WINE	
Thézac-Perricard		France	FR	WINE	
Torgan		France	FR	WINE	
Touraine		France	FR	WINE	
Touraine Noble Joué		France	FR	WINE	
Tursan		France	FR	WINE	
Urfé		France	FR	WINE	
Vacqueyras		France	FR	WINE	
Val de Loire		France	FR	WINE	
Valençay		France	FR	WINE	
Vallée du Paradis		France	FR	WINE	
Var		France	FR	WINE	
Vaucluse		France	FR	WINE	
Ventoux		France	FR	WINE	
Vicomté d'Aumelas		France	FR	WINE	
Vin d'Alsace		France	FR	WINE	
Vin de Bellet		France	FR	WINE	
Vin de Corse		France	FR	WINE	
Vin de Frontignan		France	FR	WINE	
Vin de Savoie		France	FR	WINE	
Vins fins de la Côte de Nuits		France	FR	WINE	
Vinsobres		France	FR	WINE	
Viré-Clessé		France	FR	WINE	
Volnay		France	FR	WINE	
Vosne-Romanée		France	FR	WINE	
Vougeot		France	FR	WINE	
Vouvray		France	FR	WINE	
Yonne		France	FR	WINE	
Rosée des Pyrénées Catalanes		France/ Spain	FR/E S	FOOD	Class 1.1. Fresh meat (and offal)
Aachener Printen		Germany	DE	FOOD	Class 2.4. Bread, pastry, cakes, confectionery, biscuits and other baker's wares
Aachener Weihnachts-Leberwurst / Oecher Weihnachtsleberwurst		Germany	DE	FOOD	Class 1.2. Meat products (cooked, salted, smoked, etc.)
Abensberger Spargel/Abensberger Qualitätsspargel		Germany	DE	FOOD	Class 1.6. Fruit, vegetables and cereals fresh or processed
Aischgründer Karpfen		Germany	DE	FOOD	Class 1.7. Fresh fish, molluscs, and crustaceans and products derived therefrom
Allgäuer Bergkäse		Germany	DE	FOOD	Class 1.3. Cheeses
Allgäuer Emmentaler		Germany	DE	FOOD	Class 1.3. Cheeses
Allgäuer Sennalpkäse		Germany	DE	FOOD	Class 1.3. Cheeses
Altenburger Ziegenkäse		Germany	DE	FOOD	Class 1.3. Cheeses
Ammerländer Dielenrauchschinken ; Ammerländer Katenschinken		Germany	DE	FOOD	Class 1.2. Meat products (cooked, salted, smoked, etc.)

**Avropa İttifaqı ölkələrinin ərazilərində mühafizə olunan  
coğrafi göstəricilərin siyahısı**

**The list of geographical indications that are protected  
within the territory of the European Union countries.**

**Список географических указаний, охраняемых  
на территории стран Европейского Союза**

**Bülleten № 2. 28.02.2019**

Ammerländer Schinken ; Ammerländer Knochenschinken		Germany	DE	FOOD	Class 1.2. Meat products (cooked, salted, smoked, etc.)
Bamberger Hörnla / Bamberger Hörnle / Bamberger Hörnchen		Germany	DE	FOOD	Class 1.6. Fruit, vegetables and cereals fresh or processed
Bayerische Breze / Bayerische Brezn / Bayerische Brez'n / Bayerische Brezel		Germany	DE	FOOD	Class 2.4. Bread, pastry, cakes, confectionery, biscuits and other baker's wares
Bayerischer Meerrettich ; Bayerischer Kren		Germany	DE	FOOD	Class 1.6. Fruit, vegetables and cereals fresh or processed
Bayerisches Bier		Germany	DE	FOOD	Class 2.1. Beers
Bayerisches Rindfleisch / Rindfleisch aus Bayern		Germany	DE	FOOD	Class 1.1. Fresh meat (and offal)
Beelitzer Spargel		Germany	DE	FOOD	Class 1.6. Fruit, vegetables and cereals fresh or processed
Bornheimer Spargel / Spargel aus dem Anbaugebiet Bornheim		Germany	DE	FOOD	Class 1.6. Fruit, vegetables and cereals fresh or processed
Bremer Bier		Germany	DE	FOOD	Class 2.1. Beers
Bremer Klaben		Germany	DE	FOOD	Class 2.4. Bread, pastry, cakes, confectionery, biscuits and other baker's wares
Diepholzer Moorschnucke		Germany	DE	FOOD	Class 1.1. Fresh meat (and offal)
Dithmarscher Kohl		Germany	DE	FOOD	Class 1.6. Fruit, vegetables and cereals fresh or processed
Dortmunder Bier		Germany	DE	FOOD	Class 2.1. Beers
Dresdner Christstollen / Dresdner Stollen/ Dresdner Weihnachtsstollen		Germany	DE	FOOD	Class 2.4. Bread, pastry, cakes, confectionery, biscuits and other baker's wares
Düsseldorfer Mostert/Düsseldorfer Senf Mostert/Düsseldorfer Urtyp Mostert/Aechter Düsseldorfer Mostert		Germany	DE	FOOD	Class 2.6. Mustard paste
Eichsfelder Feldgieker / Eichsfelder Feldkieker		Germany	DE	FOOD	Class 1.2. Meat products (cooked, salted, smoked, etc.)
Elbe-Saale Hopfen		Germany	DE	FOOD	Class 1.8. other products of Annex I of the Treaty (spices etc.)
Feldsalat von der Insel Reichenau		Germany	DE	FOOD	Class 1.6. Fruit, vegetables and cereals fresh or processed
Filderkraut / Filderspitzkraut		Germany	DE	FOOD	Class 1.6. Fruit, vegetables and cereals fresh or processed



**Avropa İttifaqı ölkələrinin ərazilərində mühafizə olunan  
coğrafi göstəricilərin siyahısı**

**The list of geographical indications that are protected  
within the territory of the European Union countries**

**Список географических указаний, охраняемых  
на территории стран Европейского Союза**

**Bülleten № 2. 28.02.2019**

Flönz		Germany	DE	FOOD	Class 1.2. Meat products (cooked, salted, smoked, etc.)
Frankfurter Grüne Soße / Frankfurter Grie Soß		Germany	DE	FOOD	Class 1.6. Fruit, vegetables and cereals fresh or processed
Fränkischer Grünkern		Germany	DE	FOOD	Class 1.6. Fruit, vegetables and cereals fresh or processed
Fränkischer Karpfen / Frankenkarpfen / Karpfen aus Franken		Germany	DE	FOOD	Class 1.7. Fresh fish, molluscs, and crustaceans and products derived therefrom
Glückstädter Matjes		Germany	DE	FOOD	Class 1.7. Fresh fish, molluscs, and crustaceans and products derived therefrom
Göttinger Feldkieker		Germany	DE	FOOD	Class 1.2. Meat products (cooked, salted, smoked, etc.)
Göttinger Stracke		Germany	DE	FOOD	Class 1.2. Meat products (cooked, salted, smoked, etc.)
Greußener Salami		Germany	DE	FOOD	Class 1.2. Meat products (cooked, salted, smoked, etc.)
Gurken von der Insel Reichenau		Germany	DE	FOOD	Class 1.6. Fruit, vegetables and cereals fresh or processed
Halberstädter Würstchen		Germany	DE	FOOD	Class 1.2. Meat products (cooked, salted, smoked, etc.)
Hessischer Apfelwein		Germany	DE	FOOD	Class 1.8. other products of Annex I of the Treaty (spices etc.)
Hessischer Handkäse / Hessischer Handkäs		Germany	DE	FOOD	Class 1.3. Cheeses
Hofer Bier		Germany	DE	FOOD	Class 2.1. Beers
Hofer Rindfleischwurst		Germany	DE	FOOD	Class 1.2. Meat products (cooked, salted, smoked, etc.)
Holsteiner Karpfen		Germany	DE	FOOD	Class 1.7. Fresh fish, molluscs, and crustaceans and products derived therefrom
Holsteiner Katenschinken / Holsteiner Schinken/ Holsteiner Katenrauchschinken/ Holsteiner Knochenschinken		Germany	DE	FOOD	Class 1.2. Meat products (cooked, salted, smoked, etc.)
Holsteiner Tilsiter		Germany	DE	FOOD	Class 1.3. Cheeses
Hopfen aus der Hallertau		Germany	DE	FOOD	Class 1.8. other products of Annex I of the Treaty (spices etc.)
Höri Bülle		Germany	DE	FOOD	Class 1.6. Fruit, vegetables and cereals fresh or processed
Kölsch		Germany	DE	FOOD	Class 2.1. Beers
Kulmbacher Bier		Germany	DE	FOOD	Class 2.1. Beers
Lausitzer Leinöl		Germany	DE	FOOD	Class 1.5. Oils and fats (butter, margarine, oil, etc.)

**Avropa İttifaqı ölkələrinin ərazilərində mühafizə olunan  
coğrafi göstəricilərin siyahısı**

**The list of geographical indications that are protected  
within the territory of the European Union countries.**

**Список географических указаний, охраняемых  
на территории стран Европейского Союза**

**Bülleten № 2. 28.02.2019**

Lübecker Marzipan		Germany	DE	FOOD	Class 2.4. Bread, pastry, cakes, confectionery, biscuits and other baker's wares
Lüneburger Heidekartoffeln		Germany	DE	FOOD	Class 1.6. Fruit, vegetables and cereals fresh or processed
Lüneburger Heidschnucke		Germany	DE	FOOD	Class 1.1. Fresh meat (and offal)
Mainfranken Bier		Germany	DE	FOOD	Class 2.1. Beers
Meißner Fummel		Germany	DE	FOOD	Class 2.4. Bread, pastry, cakes, confectionery, biscuits and other baker's wares
Münchener Bier		Germany	DE	FOOD	Class 2.1. Beers
Nieheimer Käse		Germany	DE	FOOD	Class 1.3. Cheeses
Nürnberger Bratwürste/Nürnberger Rostbratwürste		Germany	DE	FOOD	Class 1.2. Meat products (cooked, salted, smoked, etc.)
Nürnberger Lebkuchen		Germany	DE	FOOD	Class 2.4. Bread, pastry, cakes, confectionery, biscuits and other baker's wares
Obazda / Obatzter		Germany	DE	FOOD	Class 1.4. Other products of animal origin (eggs, honey, various dairy products except butter, etc.)
Oberlausitzer Biokarpfen		Germany	DE	FOOD	Class 1.7. Fresh fish, molluscs, and crustaceans and products derived therefrom
Oberpfälzer Karpfen		Germany	DE	FOOD	Class 1.7. Fresh fish, molluscs, and crustaceans and products derived therefrom
Odenwälder Frühstückskäse		Germany	DE	FOOD	Class 1.3. Cheeses
Oecher Puttes / Aachener Puttes		Germany	DE	FOOD	Class 1.2. Meat products (cooked, salted, smoked, etc.)
Reuther Bier		Germany	DE	FOOD	Class 2.1. Beers
Rheinisches Apfelkraut		Germany	DE	FOOD	Class 1.6. Fruit, vegetables and cereals fresh or processed
Rheinisches Zuckerrübenkraut / Rheinischer Zuckerrübensirup / Rheinisches Rübenkraut		Germany	DE	FOOD	Class 1.6. Fruit, vegetables and cereals fresh or processed
Salate von der Insel Reichenau		Germany	DE	FOOD	Class 1.6. Fruit, vegetables and cereals fresh or processed
Salzwedeler Baumkuchen		Germany	DE	FOOD	Class 2.4. Bread, pastry, cakes, confectionery, biscuits and other baker's wares
Schrobenhausener Spargel/Spargel aus dem Schrobenhausener Land/Spargel aus dem		Germany	DE	FOOD	Class 1.6. Fruit, vegetables and cereals fresh or processed

**Avropa İttifaqı ölkələrinin ərazilərində mühafizə olunan  
coğrafi göstəricilərin siyahısı**

**The list of geographical indications that are protected  
within the territory of the European Union countries**

**Список географических указаний, охраняемых  
на территории стран Европейского Союза**

**Bülleten № 2. 28.02.2019**

Anbaugebiet Schrobenhausen					
Schwäbische Maultaschen/Schwäbische Suppenmaultaschen		Germany	DE	FOOD	Class 2.7. Pasta
Schwäbische Spätzle / Schwäbische Knöpfle		Germany	DE	FOOD	Class 2.7. Pasta
Schwäbisch-Hällisches Qualitätsschweinefleisch		Germany	DE	FOOD	Class 1.1. Fresh meat (and offal)
Schwarzwälder Schinken		Germany	DE	FOOD	Class 1.2. Meat products (cooked, salted, smoked, etc.)
Schwarzwaldforelle		Germany	DE	FOOD	Class 1.7. Fresh fish, molluscs, and crustaceans and products derived therefrom
Spalt Spalter		Germany	DE	FOOD	Class 1.8. other products of Annex I of the Treaty (spices etc.)
Spargel aus Franken/Fränkischer Spargel/Franken-Spargel		Germany	DE	FOOD	Class 1.6. Fruit, vegetables and cereals fresh or processed
Spreewälder Gurken		Germany	DE	FOOD	Class 1.6. Fruit, vegetables and cereals fresh or processed
Spreewälder Meerrettich		Germany	DE	FOOD	Class 1.6. Fruit, vegetables and cereals fresh or processed
Stromberger Pflaume		Germany	DE	FOOD	Class 1.6. Fruit, vegetables and cereals fresh or processed
Tettnanger Hopfen		Germany	DE	FOOD	Class 1.8. other products of Annex I of the Treaty (spices etc.)
Thüringer Leberwurst		Germany	DE	FOOD	Class 1.2. Meat products (cooked, salted, smoked, etc.)
Thüringer Rostbratwurst		Germany	DE	FOOD	Class 1.2. Meat products (cooked, salted, smoked, etc.)
Walbecker Spargel		Germany	DE	FOOD	Class 1.6. Fruit, vegetables and cereals fresh or processed
Weideochse vom Limpurger Rind		Germany	DE	FOOD	Class 1.1. Fresh meat (and offal)
Weißlacker / Allgäuer Weißlacker		Germany	DE	FOOD	Class 1.3. Cheeses
Westfälischer Knochenschinken		Germany	DE	FOOD	Class 1.2. Meat products (cooked, salted, smoked, etc.)
Westfälischer Pumpernickel		Germany	DE	FOOD	Class 2.4. Bread, pastry, cakes, confectionery, biscuits and other baker's wares
Bärwurz		Germany	DE	SPIRITS	Other
Bayerischer Gebirgsenzian		Germany	DE	SPIRITS	Gentian
Bayerischer Kräuterlikör		Germany	DE	SPIRITS	Liqueur

**Avropa İttifaqı ölkələrinin ərazilərində mühafizə olunan  
coğrafi göstəricilərin siyahısı**

**The list of geographical indications that are protected  
within the territory of the European Union countries.**

**Список географических указаний, охраняемых  
на территории стран Европейского Союза**

**Bülleten № 2. 28.02.2019**

Benediktbeurer Klosterlikör		Germany	DE	SPIRITS	Liqueur
Berliner Kümmel		Germany	DE	SPIRITS	Liqueur
Blutwurz		Germany	DE	SPIRITS	Liqueur
Chiemseer Klosterlikör		Germany	DE	SPIRITS	Liqueur
Deutscher Weinbrand		Germany	DE	SPIRITS	Brandy or Weinbrand
Emsländer Korn/Kornbrand		Germany	DE	SPIRITS	Grain spirit
Ettaler Klosterlikör		Germany	DE	SPIRITS	Liqueur
Fränkischer Obstler		Germany	DE	SPIRITS	Fruit spirit
Fränkisches Kirschwasser		Germany	DE	SPIRITS	Fruit spirit
Fränkisches Zwetschgenwasser		Germany	DE	SPIRITS	Fruit spirit
Hamburger Kümmel		Germany	DE	SPIRITS	Liqueur
Haselünner Korn/Kornbrand		Germany	DE	SPIRITS	Grain spirit
Hasetaler Korn/Kornbrand		Germany	DE	SPIRITS	Grain spirit
Hüttentee		Germany	DE	SPIRITS	Liqueur
Königsberger Bärenfang		Germany	DE	SPIRITS	Other
Münchener Kümmel		Germany	DE	SPIRITS	Liqueur
Münsterländer Korn/Kornbrand		Germany	DE	SPIRITS	Grain spirit
Ostfriesischer Korngenever		Germany	DE	SPIRITS	Juniper-flavoured spirit drinks
Ostpreußischer Bärenfang		Germany	DE	SPIRITS	Other
Pfälzer Weinbrand		Germany	DE	SPIRITS	Brandy or Weinbrand
Rheinberger Kräuter		Germany	DE	SPIRITS	Bitter-tasting spirit drinks or bitter
Schwarzwälder Himbeergeist		Germany	DE	SPIRITS	Geist (with the name of the fruit or the raw material used)
Schwarzwälder Kirschwasser		Germany	DE	SPIRITS	Fruit spirit
Schwarzwälder Mirabellenwasser		Germany	DE	SPIRITS	Fruit spirit
Schwarzwälder Williamsbirne		Germany	DE	SPIRITS	Fruit spirit
Schwarzwälder Zwetschgenwasser		Germany	DE	SPIRITS	Fruit spirit
Sendenhorster Korn/Kornbrand		Germany	DE	SPIRITS	Grain spirit
Steinhäger		Germany	DE	SPIRITS	Juniper-flavoured spirit drinks
Ahr		Germany	DE	WINE	
Ahrtaler Landwein		Germany	DE	WINE	
Baden		Germany	DE	WINE	
Badischer Landwein		Germany	DE	WINE	
Bayerischer Bodensee-Landwein		Germany	DE	WINE	

**Avropa İttifaqı ölkələrinin ərazilərində mühafizə olunan  
coğrafi göstəricilərin siyahısı**

**The list of geographical indications that are protected  
within the territory of the European Union countries**

**Список географических указаний, охраняемых  
на территории стран Европейского Союза**

**Bülleten № 2. 28.02.2019**

Brandenburger Landwein		Germany	DE	WINE	
Bürgstadter Berg		Germany	DE	WINE	
Franken		Germany	DE	WINE	
Hessische Bergstraße		Germany	DE	WINE	
Landwein der Mosel		Germany	DE	WINE	
Landwein der Ruwer		Germany	DE	WINE	
Landwein der Saar		Germany	DE	WINE	
Landwein Main		Germany	DE	WINE	
Landwein Neckar		Germany	DE	WINE	
Landwein Oberrhein		Germany	DE	WINE	
Landwein Rhein		Germany	DE	WINE	
Landwein Rhein-Neckar		Germany	DE	WINE	
Mecklenburger Landwein		Germany	DE	WINE	
Mitteldeutscher Landwein		Germany	DE	WINE	
Mittelrhein		Germany	DE	WINE	
Mosel		Germany	DE	WINE	
Nahe		Germany	DE	WINE	
Nahegauer Landwein		Germany	DE	WINE	
Pfalz		Germany	DE	WINE	
Pfälzer Landwein		Germany	DE	WINE	
Regensburger Landwein		Germany	DE	WINE	
Rheinburgen-Landwein		Germany	DE	WINE	
Rheingau		Germany	DE	WINE	
Rheingauer Landwein		Germany	DE	WINE	
Rheinhessen		Germany	DE	WINE	
Rheinischer Landwein		Germany	DE	WINE	
Saale-Unstrut		Germany	DE	WINE	
Saarländischer Landwein		Germany	DE	WINE	
Sachsen		Germany	DE	WINE	
Sächsischer Landwein		Germany	DE	WINE	
Schleswig-Holsteinischer Landwein		Germany	DE	WINE	
Schwäbischer Landwein		Germany	DE	WINE	
Starkenburger Landwein		Germany	DE	WINE	
Taubertäler Landwein		Germany	DE	WINE	
Württemberg		Germany	DE	WINE	
Korn/Kornbrand		Germany/ Belgium/ Austria	DE/B E/AT	SPIRITS	Grain spirit
Άγιος Ματθαίος Κέρκυρας	Agios Mattheos Kerkyras	Greece	GR	FOOD	Class 1.5. Oils and fats (butter, margarine, oil, etc.)

**Avropa İttifaqı ölkələrinin ərazilərində mühafizə olunan  
coğrafi göstəricilərin siyahısı**

**The list of geographical indications that are protected  
within the territory of the European Union countries.**

**Список географических указаний, охраняемых  
на территории стран Европейского Союза**

**Bülleten № 2. 28.02.2019**

Αγουρέλαιο Χαλκιδικής	Agoureleo Chalkidikis	Greece	GR	FOOD	Class 1.5. Oils and fats (butter, margarine, oil, etc.)
Ακτινίδιο Πιερίας	Aktinidio Pierias	Greece	GR	FOOD	Class 1.6. Fruit, vegetables and cereals fresh or processed
Ακτινίδιο Σπερχειού	Aktinidio Sperchiou	Greece	GR	FOOD	Class 1.6. Fruit, vegetables and cereals fresh or processed
Ανεβατό	Anevato	Greece	GR	FOOD	Class 1.3. Cheeses
Αποκορώνας Χανίων Κρήτης	Apokoronas Chanion Kritis	Greece	GR	FOOD	Class 1.5. Oils and fats (butter, margarine, oil, etc.)
Αρνάκι Ελασσόνας	Arnaki Elassonas	Greece	GR	FOOD	Class 1.1. Fresh meat (and offal)
Αρχάνες Ηρακλείου Κρήτης	Arxanes Irakliou Kritis	Greece	GR	FOOD	Class 1.5. Oils and fats (butter, margarine, oil, etc.)
Αυγοτάραχο Μεσολογγίου	Avgotaracho Messolongiou	Greece	GR	FOOD	Class 1.7. Fresh fish, molluscs, and crustaceans and products derived therefrom
Βιάννος Ηρακλείου Κρήτης	Viannos Irakliou Kritis	Greece	GR	FOOD	Class 1.5. Oils and fats (butter, margarine, oil, etc.)
Βόρειος Μυλοπόταμος Ρεθύμνης Κρήτης	Vorios Mylopotamos Rethymnis Kritis	Greece	GR	FOOD	Class 1.5. Oils and fats (butter, margarine, oil, etc.)
Γαλανό Μεταγγισίου Χαλκιδικής	Galano Metaggitsiou Chalkidikis	Greece	GR	FOOD	Class 1.5. Oils and fats (butter, margarine, oil, etc.)
Γαλοτύρι	Galotyri	Greece	GR	FOOD	Class 1.3. Cheeses
Γραβιέρα Αγράφων	Graviera Agrafon	Greece	GR	FOOD	Class 1.3. Cheeses
Γραβιέρα Κρήτης	Graviera Kritis	Greece	GR	FOOD	Class 1.3. Cheeses
Γραβιέρα Νάξου	Graviera Naxou	Greece	GR	FOOD	Class 1.3. Cheeses
Ελιά Καλαμάτας	Elia Kalamatas	Greece	GR	FOOD	Class 1.6. Fruit, vegetables and cereals fresh or processed
Εξαιρετικό παρθένο ελαιόλαδο "Τροιζηνία"	Exeretiko partheno eleolado "Trizinia"	Greece	GR	FOOD	Class 1.5. Oils and fats (butter, margarine, oil, etc.)
Εξαιρετικό παρθένο ελαιόλαδο Θραψανό	Exeretiko partheno eleolado Thrapsano	Greece	GR	FOOD	Class 1.5. Oils and fats (butter, margarine, oil, etc.)
Εξαιρετικό Παρθένο Ελαιόλαδο Σέλινο Κρήτης	Exeretiko Partheno Eleolado Selino Kritis	Greece	GR	FOOD	Class 1.5. Oils and fats (butter, margarine, oil, etc.)
Ζάκυνθος	Zakynthos	Greece	GR	FOOD	Class 1.5. Oils and fats (butter, margarine, oil, etc.)
Θάσος	Thassos	Greece	GR	FOOD	Class 1.5. Oils and fats (butter, margarine, oil, etc.)
Θρούμπα Αμπαδιάς Ρεθύμνης Κρήτης	Throumpa Ampadias Rethymnis Kritis	Greece	GR	FOOD	Class 1.6. Fruit, vegetables and cereals fresh or processed



**Avropa İttifaqı ölkələrinin ərazilərində mühafizə olunan  
coğrafi göstəricilərin siyahısı**

**The list of geographical indications that are protected  
within the territory of the European Union countries**

**Список географических указаний, охраняемых  
на территории стран Европейского Союза**

**Bülleten № 2. 28.02.2019**

Θρούμπα Θάσου	Throumpa Thassou	Greece	GR	FOOD	Class 1.6. Fruit, vegetables and cereals fresh or processed
Θρούμπα Χίου	Throumpa Chiou	Greece	GR	FOOD	Class 1.6. Fruit, vegetables and cereals fresh or processed
Καλαθάκι Λήμνου	Kalathaki Limnou	Greece	GR	FOOD	Class 1.3. Cheeses
Καλαμάτα	Kalamata	Greece	GR	FOOD	Class 1.5. Oils and fats (butter, margarine, oil, etc.)
Κασέρι	Kasseri	Greece	GR	FOOD	Class 1.3. Cheeses
Κατίκι Δομοκού	Katiki Domokou	Greece	GR	FOOD	Class 1.3. Cheeses
Κατσικάκι Ελασσόνας	Katsikaki Elassonas	Greece	GR	FOOD	Class 1.1. Fresh meat (and offal)
Κελυφωτό φυστίκι Φθιώτιδας	Kelifoto fystiki Fthiotidas	Greece	GR	FOOD	Class 1.6. Fruit, vegetables and cereals fresh or processed
Κεράσια τραγανά Ροδοχωρίου	Kerassia Tragana Rodochoriou	Greece	GR	FOOD	Class 1.6. Fruit, vegetables and cereals fresh or processed
Κεφαλογραβιέρα	Kefalograviera	Greece	GR	FOOD	Class 1.3. Cheeses
Κεφαλονιά	Kefalonia	Greece	GR	FOOD	Class 1.5. Oils and fats (butter, margarine, oil, etc.)
Κολυμβάρι Χανίων Κρήτης	Kolymvari Chanion Kritis	Greece	GR	FOOD	Class 1.5. Oils and fats (butter, margarine, oil, etc.)
Κονσερβολιά Αμφίσσης	Konservolia Amfissis	Greece	GR	FOOD	Class 1.6. Fruit, vegetables and cereals fresh or processed
Κονσερβολιά Άρτας	Konservolia Artas	Greece	GR	FOOD	Class 1.6. Fruit, vegetables and cereals fresh or processed
Κονσερβολιά Αταλάντης	Konservolia Atalantis	Greece	GR	FOOD	Class 1.6. Fruit, vegetables and cereals fresh or processed
Κονσερβολιά Πηλίου Βόλου	Konservolia Piliou Volou	Greece	GR	FOOD	Class 1.6. Fruit, vegetables and cereals fresh or processed
Κονσερβολιά Ροβίων	Konservolia Rovion	Greece	GR	FOOD	Class 1.6. Fruit, vegetables and cereals fresh or processed
Κονσερβολιά Στυλίδας	Konservolia Stylidas	Greece	GR	FOOD	Class 1.6. Fruit, vegetables and cereals fresh or processed
Κοπανιστή	Kopanisti	Greece	GR	FOOD	Class 1.3. Cheeses
Κορινθιακή Σταφίδα Βοστίτσα	Korinthiaki Stafida Vostitsa	Greece	GR	FOOD	Class 1.6. Fruit, vegetables and cereals fresh or processed
Κουμ Κουάτ Κέρκυρας	Koum kouat Kerkyras	Greece	GR	FOOD	Class 1.6. Fruit, vegetables and cereals fresh or processed
Κρανίδι Αργολίδας	Kranidi Argolidas	Greece	GR	FOOD	Class 1.5. Oils and fats (butter, margarine, oil, etc.)
Κρητικό παξιμάδι	Kritiko paximadi	Greece	GR	FOOD	Class 2.4. Bread, pastry, cakes, confectionery, biscuits and other baker's wares
Κροκεές Λακωνίας	Krokees Lakonias	Greece	GR	FOOD	Class 1.5. Oils and fats (butter, margarine, oil, etc.)
Κρόκος Κοζάνης	Krokos Kozanis	Greece	GR	FOOD	Class 1.8. other products of Annex I of the Treaty (spices etc.)
Λαδοτύρι Μυτιλήνης	Ladotyri Mytilinis	Greece	GR	FOOD	Class 1.3. Cheeses

**Avropa İttifaqı ölkələrinin ərazilərində mühafizə olunan  
coğrafi göstəricilərin siyahısı**

**The list of geographical indications that are protected  
within the territory of the European Union countries.**

**Список географических указаний, охраняемых  
на территории стран Европейского Союза**

**Bülleten № 2. 28.02.2019**

Λακωνία	Lakonia	Greece	GR	FOOD	Class 1.5. Oils and fats (butter, margarine, oil, etc.)
Λέσβος ; Μυτιλήνη	Lesvos ; Mytilini	Greece	GR	FOOD	Class 1.5. Oils and fats (butter, margarine, oil, etc.)
Λυγουριό Ασκληπιείου	Lygourio Asklipiou	Greece	GR	FOOD	Class 1.5. Oils and fats (butter, margarine, oil, etc.)
Μανούρι	Manouri	Greece	GR	FOOD	Class 1.3. Cheeses
Μανταρίνι Χίου	Mandarini Chiou	Greece	GR	FOOD	Class 1.6. Fruit, vegetables and cereals fresh or processed
Μαστίχα Χίου	Masticha Chiou	Greece	GR	FOOD	Class 2.5. Natural gums and resins
Μαστιχέλαιο Χίου	Mastichelaio Chiou	Greece	GR	FOOD	Class 3.2. Essential oils
Μελεκούνι	Melekouni	Greece	GR	FOOD	Class 2.4. Bread, pastry, cakes, confectionery, biscuits and other baker's wares
Μέλι Ελάτης Μαινάλου Βανίλια	Meli Elatis Menalou Vanilia	Greece	GR	FOOD	Class 1.8. other products of Annex I of the Treaty (spices etc.)
Μεσσαρά	Messara	Greece	GR	FOOD	Class 1.5. Oils and fats (butter, margarine, oil, etc.)
Μετσοβόνη	Metsovone	Greece	GR	FOOD	Class 1.3. Cheeses
Μήλα Ζαγοράς Πηλίου	Mila Zagoras Piliou	Greece	GR	FOOD	Class 1.6. Fruit, vegetables and cereals fresh or processed
Μήλα Ντελίσιους Πιλαφά Τριπόλεως	Mila Delicious Pilafa Tripoleos	Greece	GR	FOOD	Class 1.6. Fruit, vegetables and cereals fresh or processed
Μήλο Καστοριάς	Milo Kastorias	Greece	GR	FOOD	Class 1.6. Fruit, vegetables and cereals fresh or processed
Μπάτζος	Batzos	Greece	GR	FOOD	Class 1.3. Cheeses
Ξερά σύκα Κύμης	Xera syka Kymis	Greece	GR	FOOD	Class 1.6. Fruit, vegetables and cereals fresh or processed
Ξηρά Σύκα Ταξιάρχη	Xira Syka Taxiarchi	Greece	GR	FOOD	Class 1.6. Fruit, vegetables and cereals fresh or processed
Ξύγαλο Σητείας / Ξίγαλο Σητείας	Xygalo Siteias / Xigalo Siteias	Greece	GR	FOOD	Class 1.3. Cheeses
Ξυνομυζήθρα Κρήτης	Xynomyzithra Kritis	Greece	GR	FOOD	Class 1.3. Cheeses
Ολυμπία	Olympia	Greece	GR	FOOD	Class 1.5. Oils and fats (butter, margarine, oil, etc.)
Πατάτα Κάτω Νευροκοπίου	Patata Kato Nevrokopiou	Greece	GR	FOOD	Class 1.6. Fruit, vegetables and cereals fresh or processed
Πατάτα Νάξου	Patata Naxou	Greece	GR	FOOD	Class 1.6. Fruit, vegetables and cereals fresh or processed
Πεζά Ηρακλείου Κρήτης	Peza Irakliou Kritis	Greece	GR	FOOD	Class 1.5. Oils and fats (butter, margarine, oil, etc.)
Πέτρινα Λακωνίας	Petrina Lakonias	Greece	GR	FOOD	Class 1.5. Oils and fats (butter, margarine, oil, etc.)
Πευκοθυμαρόμελο Κρήτης	Pefkothymaromelo Kritis	Greece	GR	FOOD	Class 1.4. Other products of animal origin (eggs, honey, various dairy products except butter, etc.)

**Avropa İttifaqı ölkələrinin ərazilərində mühafizə olunan  
coğrafi göstəricilərin siyahısı**

**The list of geographical indications that are protected  
within the territory of the European Union countries**

**Список географических указаний, охраняемых  
на территории стран Европейского Союза**

**Bülleten № 2. 28.02.2019**

Πηχτόγαλο Χανίων	Pichtogalo Chanion	Greece	GR	FOOD	Class 1.3. Cheeses
Πορτοκάλια Μάλεμε Χανίων Κρήτης	Portokalia Maleme Chanion Kritis	Greece	GR	FOOD	Class 1.6. Fruit, vegetables and cereals fresh or processed
Πράσινες Ελιές Χαλκιδικής	Prasines Elies Chalkidikis	Greece	GR	FOOD	Class 1.6. Fruit, vegetables and cereals fresh or processed
Πρέβεζα	Preveza	Greece	GR	FOOD	Class 1.5. Oils and fats (butter, margarine, oil, etc.)
Ροδάκινα Νάουσας	Rodakina Naoussas	Greece	GR	FOOD	Class 1.6. Fruit, vegetables and cereals fresh or processed
Ρόδος	Rodos	Greece	GR	FOOD	Class 1.5. Oils and fats (butter, margarine, oil, etc.)
Σάμος	Samos	Greece	GR	FOOD	Class 1.5. Oils and fats (butter, margarine, oil, etc.)
Σαν Μιχάλη	San Michali	Greece	GR	FOOD	Class 1.3. Cheeses
Σητεία Λασιθίου Κρήτης	Sitia Lasithiou Kritis	Greece	GR	FOOD	Class 1.5. Oils and fats (butter, margarine, oil, etc.)
Σταφίδα Ζακύνθου	Stafida Zakynthou	Greece	GR	FOOD	Class 1.6. Fruit, vegetables and cereals fresh or processed
Σταφίδα Ηλείας	Stafida Ilias	Greece	GR	FOOD	Class 1.6. Fruit, vegetables and cereals fresh or processed
Σταφίδα Σουλτανίνα Κρήτης	Stafida Soutanina Kritis	Greece	GR	FOOD	Class 1.6. Fruit, vegetables and cereals fresh or processed
Σύκα Βραβρώνας Μαρκοπούλου Μεσογείων	Syka Vravronas Markopoulou Mesogeion	Greece	GR	FOOD	Class 1.6. Fruit, vegetables and cereals fresh or processed
Σφέλα	Sfela	Greece	GR	FOOD	Class 1.3. Cheeses
Τοματάκι Σαντορίνης	Tomataki Santorinis	Greece	GR	FOOD	Class 1.6. Fruit, vegetables and cereals fresh or processed
Τσακωνική μελιτζάνα Λεωνιδίου	Tsakoniki Melitzana Leonidiou	Greece	GR	FOOD	Class 1.6. Fruit, vegetables and cereals fresh or processed
Τσίχλα Χίου	Tsikla Chiou	Greece	GR	FOOD	Class 2.5. Natural gums and resins
Φάβα Σαντορίνης	Fava Santorinis	Greece	GR	FOOD	Class 1.6. Fruit, vegetables and cereals fresh or processed
Φάβα Φενεού	Fava Feneou	Greece	GR	FOOD	Class 1.6. Fruit, vegetables and cereals fresh or processed
Φασόλια (Γίγαντες Ελέφαντες) Πρεσπών Φλώρινας	Fasolia Gigantes Elefantas Prespon Florinas	Greece	GR	FOOD	Class 1.6. Fruit, vegetables and cereals fresh or processed
Φασόλια (πλακέ μεγαλόσπερμα) Πρεσπών Φλώρινας	Fasolia (plake megalosperma) Prespon Florinas	Greece	GR	FOOD	Class 1.6. Fruit, vegetables and cereals fresh or processed
Φασόλια Βανίλιες Φενεού	Fasolia Vanilies Feneou	Greece	GR	FOOD	Class 1.6. Fruit, vegetables and cereals fresh or processed

**Avropa İttifaqı ölkələrinin ərazilərində mühafizə olunan  
coğrafi göstəricilərin siyahısı**

**The list of geographical indications that are protected  
within the territory of the European Union countries.**

**Список географических указаний, охраняемых  
на территории стран Европейского Союза**

**Bülleten № 2. 28.02.2019**

ΦΑΣΟΛΙΑ ΓΙΓΑΝΤΕΣ — ΕΛΕΦΑΝΤΕΣ ΚΑΣΤΟΡΙΑΣ	Fasolia Gigantes — Elefantas Kastorias	Greece	GR	FOOD	Class 1.6. Fruit, vegetables and cereals fresh or processed
Φασόλια γίγαντες ελέφαντες Κάτω Νευροκοπίου	Fassolia Gigantes Elefantas Kato Nevrokopiou	Greece	GR	FOOD	Class 1.6. Fruit, vegetables and cereals fresh or processed
Φασόλια κοινά μεσόσπερμα Κάτω Νευροκοπίου	Fassolia kina Messosperma Kato Nevrokopiou	Greece	GR	FOOD	Class 1.6. Fruit, vegetables and cereals fresh or processed
Φέτα	Feta	Greece	GR	FOOD	Class 1.3. Cheeses
Φιρίκι Πηλίου	Firiki Piliou	Greece	GR	FOOD	Class 1.6. Fruit, vegetables and cereals fresh or processed
Φοινίκι Λακωνίας	Finiki Lakonias	Greece	GR	FOOD	Class 1.5. Oils and fats (butter, margarine, oil, etc.)
Φορμαέλλα Αράχωβας Παρνασσού	Formaella Arachovas Parnassou	Greece	GR	FOOD	Class 1.3. Cheeses
Φυστίκι Αίγινας	Fystiki Aeginas	Greece	GR	FOOD	Class 1.6. Fruit, vegetables and cereals fresh or processed
Φυστίκι Μεγάρων	Fystiki Megaron	Greece	GR	FOOD	Class 1.6. Fruit, vegetables and cereals fresh or processed
Χανιά Κρήτης	Chania Kritis	Greece	GR	FOOD	Class 1.5. Oils and fats (butter, margarine, oil, etc.)
Κίτρο Νάξου	Kitro of Naxos	Greece	GR	SPIRITS	Liqueur
Κουμκουάτ Κέρκυρας	Koum Kouat of Corfu	Greece	GR	SPIRITS	Liqueur
Μαστίχα Χίου	Masticha of Chios	Greece	GR	SPIRITS	Liqueur
Ούζο Θράκης	Ouzo of Thrace	Greece	GR	SPIRITS	Distilled anis
Ούζο Καλαμάτας	Ouzo of Kalamata	Greece	GR	SPIRITS	Distilled anis
Ούζο Μακεδονίας	Ouzo of Macedonia	Greece	GR	SPIRITS	Distilled anis
Ούζο Μυτιλήνης	Ouzo of Mitilene	Greece	GR	SPIRITS	Distilled anis
Ούζο Πλωμαρίου	Ouzo of Plomari	Greece	GR	SPIRITS	Distilled anis
Τεντούρα	Tentoura	Greece	GR	SPIRITS	Liqueur
Τσικουδιά	Tsikoudia	Greece	GR	SPIRITS	Grape marc spirit or grape marc
Τσικουδιά Κρήτης	Tsikoudia of Crete	Greece	GR	SPIRITS	Grape marc spirit or grape marc
Τσίπουρο	Tsipouro	Greece	GR	SPIRITS	Grape marc spirit or grape marc
Τσίπουρο Θεσσαλίας	Tsipouro of Thessaly	Greece	GR	SPIRITS	Grape marc spirit or grape marc
Τσίπουρο Μακεδονίας	Tsipouro of Macedonia	Greece	GR	SPIRITS	Grape marc spirit or grape marc

**Avropa İttifaqı ölkələrinin ərazilərində mühafizə olunan  
coğrafi göstəricilərin siyahısı**

**The list of geographical indications that are protected  
within the territory of the European Union countries**

**Список географических указаний, охраняемых  
на территории стран Европейского Союза**

**Bülleten № 2. 28.02.2019**

Τσίπουρο Τυρνάβου	Tsipouro of Tyrnavos	Greece	GR	SPIRITS	Grape marc spirit or grape marc
Κως	Kos	Greece	GR	WINE	
Malvasia Πάρου	Malvasia Paros	Greece	GR	WINE	
Malvasia Σητείας	Malvasia Sitia	Greece	GR	WINE	
Malvasia Χάνδακας-Candia		Greece	GR	WINE	
Άβδηρα	Avdira	Greece	GR	WINE	
Άγιο Όρος	Mount Athos/ Holly Mount Athos/Holly Mountain Athos/Mont Athos/Άγιο Όρος Άθως	Greece	GR	WINE	
Αγορά	Agora	Greece	GR	WINE	
Αγχίαλος	Anchialos	Greece	GR	WINE	
Αιγαίο Πέλαγος	Aegean Sea/Aigaio Pelagos	Greece	GR	WINE	
Αμύνταιο	Amyndeon	Greece	GR	WINE	
Ανάβυσσος	Anavysos	Greece	GR	WINE	
Αργολίδα	Argolida	Greece	GR	WINE	
Αρκαδία	Arkadia	Greece	GR	WINE	
Αρχάνες	Archanes	Greece	GR	WINE	
Αττική	Attiki	Greece	GR	WINE	
Αχαΐα	Achaia	Greece	GR	WINE	
Βελβεντό	Velvento	Greece	GR	WINE	
Βερντέα Ζακύνθου	Verdean of Zakynthos	Greece	GR	WINE	
Γεράνεια	Gerania	Greece	GR	WINE	
Γουμένισσα	Goumenissa	Greece	GR	WINE	
Γρεβενά	Grevena	Greece	GR	WINE	
Δαφνές	Dafnes	Greece	GR	WINE	
Δράμα	Drama	Greece	GR	WINE	
Δωδεκάνησος	Dodekanese	Greece	GR	WINE	
Έβρος	Evros	Greece	GR	WINE	
Ελασσόνα	Elassona	Greece	GR	WINE	
Επανομή	Epanomi	Greece	GR	WINE	
Εύβοια	Evia	Greece	GR	WINE	
Ζάκυνθος	Zakynthos	Greece	GR	WINE	
Ζίτσα	Zitsa	Greece	GR	WINE	
Ηλεία	Ilia	Greece	GR	WINE	
Ημαθία	Imathia	Greece	GR	WINE	
Ήπειρος	Epirus	Greece	GR	WINE	
Ηράκλειο	Iraklio	Greece	GR	WINE	
Θάσος	Thasos	Greece	GR	WINE	
Θαψανά	Thapsana	Greece	GR	WINE	
Θεσσαλία	Thessalia	Greece	GR	WINE	
Θεσσαλονίκη	Thessaloniki	Greece	GR	WINE	
Θήβα	Thiva	Greece	GR	WINE	

**Avropa İttifaqı ölkələrinin ərazilərində mühafizə olunan  
coğrafi göstəricilərin siyahısı**

**The list of geographical indications that are protected  
within the territory of the European Union countries.**

**Список географических указаний, охраняемых  
на территории стран Европейского Союза**

Bülleten № 2. 28.02.2019

Θράκη	Thrace	Greece	GR	WINE	
Ίκαρία	Ikaria	Greece	GR	WINE	
Ίλιον	Ilion	Greece	GR	WINE	
Ίσμαρος	Ismaros	Greece	GR	WINE	
Ιωάννινα	Ioannina	Greece	GR	WINE	
Καβάλα	Kavala	Greece	GR	WINE	
Καρδίτσα	Karditsa	Greece	GR	WINE	
Κάρυστος	Karystos	Greece	GR	WINE	
Καστοριά	Kastoria	Greece	GR	WINE	
Κέρκυρα	Corfu	Greece	GR	WINE	
Κίσσαμος	Kissamos	Greece	GR	WINE	
Κλημέντι	Klimenti	Greece	GR	WINE	
Κοζάνη	Kozani	Greece	GR	WINE	
Κοιλιάδα Αταλάντης	Atalanti Valley	Greece	GR	WINE	
Κόρινθος	Κορινθία /Korinthos/Kori nthia	Greece	GR	WINE	
Κρανιά	Krania	Greece	GR	WINE	
Κραννώνα	Krannona	Greece	GR	WINE	
Κρήτη	Crete	Greece	GR	WINE	
Κυκλάδες	Cyclades	Greece	GR	WINE	
Λακωνία	Lakonia	Greece	GR	WINE	
Λασιθί	Lasithi	Greece	GR	WINE	
Λέσβος	Lesvos	Greece	GR	WINE	
Λετρίνοι	Letrini	Greece	GR	WINE	
Λευκάδα	Lefkada	Greece	GR	WINE	
Ληλάντιο Πεδίο	Lilantio Pedio/Lilantio Field	Greece	GR	WINE	
Λήμνος	Limnos	Greece	GR	WINE	
Μαγνησία	Magnisia	Greece	GR	WINE	
Μακεδονία	Macedonia	Greece	GR	WINE	
Μαντζαβινάτα	Mantzavinata	Greece	GR	WINE	
Μαντινεία	Mantinia	Greece	GR	WINE	
Μαρκόπουλο	Markopoulo	Greece	GR	WINE	
Μαρτίνο	Martino	Greece	GR	WINE	
Μαυροδάφνη Κεφαλληνίας	Mavrodaphne of Kefalonia	Greece	GR	WINE	
Μαυροδάφνη Πατρών	Mavrodaphni of Patra	Greece	GR	WINE	
Μεσενικόλα	Mesenikola	Greece	GR	WINE	
Μεσσηνία	Messinia	Greece	GR	WINE	
Μεταξάτων	Metaxata	Greece	GR	WINE	
Μετέωρα	Meteora	Greece	GR	WINE	
Μέτσοβο	Metsovo	Greece	GR	WINE	
Μονεμβασία- Malvasia	Monemvasia- Malvasia	Greece	GR	WINE	
Μοσχάτο Πατρών	Muscat of Patra	Greece	GR	WINE	
Μοσχάτος Κεφαλληνίας	Muscat of Kefalonia /	Greece	GR	WINE	

**Avropa İttifaqı ölkələrinin ərazilərində mühafizə olunan  
coğrafi göstəricilərin siyahısı**

**The list of geographical indications that are protected  
within the territory of the European Union countries**

**Список географических указаний, охраняемых  
на территории стран Европейского Союза**

**Bülleten № 2. 28.02.2019**

	Muscat de Céphalonie				
Μοσχάτος Λήμνου	Muscat of Limnos	Greece	GR	WINE	
Μοσχάτος Ρίου Πάτρας	Muscat of Rio Patra	Greece	GR	WINE	
Μοσχάτος Ρόδου	Muscat of Rodos	Greece	GR	WINE	
Νάουσα	Naoussa	Greece	GR	WINE	
Νέα Μεσημβρία	Nea Mesimvria	Greece	GR	WINE	
Νεμέα	Nemea	Greece	GR	WINE	
Οπούντια Λοκρίδας	Opountia Locris	Greece	GR	WINE	
Παγγαίο	Paggeio /Pangeon	Greece	GR	WINE	
Παλλήνη	Ilion	Greece	GR	WINE	
Παρνασσός	Parnassos	Greece	GR	WINE	
Πάρος	Paros	Greece	GR	WINE	
Πάτρα	Patra	Greece	GR	WINE	
Πεζά	Peza	Greece	GR	WINE	
Πέλλα	Pella	Greece	GR	WINE	
Πελοπόννησος	Peloponnese	Greece	GR	WINE	
Πιερία	Pieria	Greece	GR	WINE	
Πισάτις	Pisatis	Greece	GR	WINE	
Πλαγιές Αιγιαλείας	Slopes of Aigialia	Greece	GR	WINE	
Πλαγιές Αίνου	Slopes of Ainos	Greece	GR	WINE	
Πλαγιές Αμπέλου	Slopes of ampelos	Greece	GR	WINE	
Πλαγιές Βερτίσκου	Slopes of Vertiskos	Greece	GR	WINE	
Πλαγιές Κιθαιρώνα	Slopes of Kithaironas	Greece	GR	WINE	
Πλαγιές Κνημίδας	Slopes of Knimida	Greece	GR	WINE	
Πλαγιές Μελίτων	Slopes of Meliton	Greece	GR	WINE	
Πλαγιές Πάικου	Slopes of Paiko	Greece	GR	WINE	
Πλαγιές Πάρνηθας	Slopes of Parnitha	Greece	GR	WINE	
Πλαγιές Πεντελικού	Slopes of Pendeliko / Βόρειες Πλαγιές Πεντελικού	Greece	GR	WINE	
Πυλία	Pylia	Greece	GR	WINE	
Ραψάνη	Rapsani	Greece	GR	WINE	
Ρέθυμνο	Rethimno	Greece	GR	WINE	
Ρετσίνα Αττικής	Retsina of Attiki	Greece	GR	WINE	



**Avropa İttifaqı ölkələrinin ərazilərində mühafizə olunan  
coğrafi göstəricilərin siyahısı**

**The list of geographical indications that are protected  
within the territory of the European Union countries.**

**Список географических указаний, охраняемых  
на территории стран Европейского Союза**

Bülleten № 2. 28.02.2019

Ρετσίνα Βοιωτίας	Retsina of Viotia	Greece	GR	WINE	
Ρετσίνα Γιάλτρων	Retsina of Gialtra	Greece	GR	WINE	
Ρετσίνα Εύβοιας	Retsina of Evoia	Greece	GR	WINE	
Ρετσίνα Θηβών (Βοιωτίας)	Retsina of Thebes (Voiotias)	Greece	GR	WINE	
Ρετσίνα Καρύστου	Retsina of Karystos	Greece	GR	WINE	
Ρετσίνα Κορωπίου	Ρετσίνα Κορωπίου Αττικής/Retsin a of Koropi/Retsina of Koropi Attiki	Greece	GR	WINE	
Ρετσίνα Κρωπίας	Ρετσίνα Κορωπίου Αττικής/Retsin a of Koropi/Retsina of Koropi Attiki	Greece	GR	WINE	
Ρετσίνα Λιοπεσίου	Ρετσίνα Παιανίας Αττικής/Retsin a of Paiania /Retsina of Paiania Attiki	Greece	GR	WINE	
Ρετσίνα Μαρκόπουλου (Αττικής)	Retsina of Markopoulo (Attiki)	Greece	GR	WINE	
Ρετσίνα Μεγάρων	Retsina of Megara (Attiki)	Greece	GR	WINE	
Ρετσίνα Μεσογείων (Αττικής)	Retsina of Mesogia (Attiki)	Greece	GR	WINE	
Ρετσίνα Παιανίας	Ρετσίνα Παιανίας Αττικής/Retsin a of Paiania /Retsina of Paiania Attiki	Greece	GR	WINE	
Ρετσίνα Παλλήνης	Retsina of Pikermi (Attiki)	Greece	GR	WINE	
Ρετσίνα Πικερμίου	Ρετσίνα Πικερμίου (Αττικής) /Retsina of Pikermi (Attiki)	Greece	GR	WINE	
Ρετσίνα Σπάτων	Ρετσίνα Σπάτων (Αττικής) /	Greece	GR	WINE	

**Avropa İttifaqı ölkələrinin ərazilərində mühafizə olunan  
coğrafi göstəricilərin siyahısı**

**The list of geographical indications that are protected  
within the territory of the European Union countries**

**Список географических указаний, охраняемых  
на территории стран Европейского Союза**

**Bülleten № 2. 28.02.2019**

	Retsina of Spata (Attiki)				
Ρετσίνα Χαλκίδας (Ευβοίας)	Retsina of Halkida (Evoia)	Greece	GR	WINE	
Ριτσώνα	Ritsona	Greece	GR	WINE	
Ρόδος	Rhodes	Greece	GR	WINE	
Ρομπόλα Κεφαλληνίας	Robola of Kefalonia	Greece	GR	WINE	
Σάμος	Samos	Greece	GR	WINE	
Σαντορίνη	Santorini	Greece	GR	WINE	
Σέρρες	Serres	Greece	GR	WINE	
Σητεία	Sitia	Greece	GR	WINE	
Σιάτιστα	Siatista	Greece	GR	WINE	
Σιθωνία	Sithonia	Greece	GR	WINE	
Σπάτα	Spata	Greece	GR	WINE	
Στερεά Ελλάδα	Stereia Ellada	Greece	GR	WINE	
Τεγέα	Tegea	Greece	GR	WINE	
Τριφυλία	Trifilia	Greece	GR	WINE	
Τύρναβος	Tyrnavos	Greece	GR	WINE	
Φθιώτιδα	Fthiotida/Phthiotis	Greece	GR	WINE	
Φλώρινα	Florina	Greece	GR	WINE	
Χαλικούνα	Halikouna	Greece	GR	WINE	
Χαλκιδική	Halkidiki	Greece	GR	WINE	
Χάνδακας - Candia	Candia	Greece	GR	WINE	
Χανιά	Chania	Greece	GR	WINE	
Χίος	Chios	Greece	GR	WINE	
Ούζο	Ouzo	Greece/Cyprus	GR/CY	SPIRITS	Distilled anis
Alföldi kamillavirágzat		Hungary	HU	FOOD	Class 1.8. other products of Annex I of the Treaty (spices etc.)
Budapesti téliszalámi		Hungary	HU	FOOD	Class 1.2. Meat products (cooked, salted, smoked, etc.)
Csabai kolbász/Csabai vastagkolbász		Hungary	HU	FOOD	Class 1.2. Meat products (cooked, salted, smoked, etc.)
Gönci kajsziparack		Hungary	HU	FOOD	Class 1.6. Fruit, vegetables and cereals fresh or processed
Gyulai kolbász / Gyulai pároskolbász		Hungary	HU	FOOD	Class 1.2. Meat products (cooked, salted, smoked, etc.)
Hajdúsági torma		Hungary	HU	FOOD	Class 1.6. Fruit, vegetables and cereals fresh or processed
Kalocsai fűszerpaprika-örlemény		Hungary	HU	FOOD	Class 1.8. other products of Annex I of the Treaty (spices etc.)
Magyar szürkemarha hús		Hungary	HU	FOOD	Class 1.1. Fresh meat (and offal)
Makói petrezselyemgyökér		Hungary	HU	FOOD	Class 1.6. Fruit, vegetables and cereals fresh or processed
Makói vöröshagyma ; Makói hagyma		Hungary	HU	FOOD	Class 1.6. Fruit, vegetables and cereals fresh or processed

**Avropa İttifaqı ölkələrinin ərazilərində mühafizə olunan  
coğrafi göstəricilərin siyahısı**

**The list of geographical indications that are protected  
within the territory of the European Union countries.**

**Список географических указаний, охраняемых  
на территории стран Европейского Союза**

**Bülleten № 2. 28.02.2019**

Szegedi fűszerpaprika- őrlemény/Szegedi paprika		Hungary	HU	FOOD	Class 1.8. other products of Annex I of the Treaty (spices etc.)
Szegedi szalámi ; Szegedi téliszalámi		Hungary	HU	FOOD	Class 1.2. Meat products (cooked, salted, smoked, etc.)
Szentesi paprika		Hungary	HU	FOOD	Class 1.6. Fruit, vegetables and cereals fresh or processed
Szőregi rózsatő		Hungary	HU	FOOD	Class 3.5. Flowers and ornamental plants
Békési Szilvapálinka		Hungary	HU	SPIRITS	Fruit spirit
Gönci Barackpálinka		Hungary	HU	SPIRITS	Fruit spirit
Kecskeméti Barackpálinka		Hungary	HU	SPIRITS	Fruit spirit
Szabolcsi Almapálinka		Hungary	HU	SPIRITS	Fruit spirit
Szatmári Szilvapálinka		Hungary	HU	SPIRITS	Fruit spirit
Törkölypálinka		Hungary	HU	SPIRITS	Grape marc spirit or grape marc
Újfehértói meggypálinka		Hungary	HU	SPIRITS	Fruit spirit
Badacsony		Hungary	HU	WINE	
Badacsonyi		Hungary	HU	WINE	
Balaton		Hungary	HU	WINE	
Balatonboglár		Hungary	HU	WINE	
Balatonboglári		Hungary	HU	WINE	
Balaton-felvidék		Hungary	HU	WINE	
Balaton-felvidéki		Hungary	HU	WINE	
Balatonfüred-Csopak		Hungary	HU	WINE	
Balatonfüred-Csopaki		Hungary	HU	WINE	
Balatoni		Hungary	HU	WINE	
Balatonmelléki		Hungary	HU	WINE	
Bükk		Hungary	HU	WINE	
Bükki		Hungary	HU	WINE	
Csongrád		Hungary	HU	WINE	
Csongrádi		Hungary	HU	WINE	
Debrői Hárslevelű		Hungary	HU	WINE	
Duna		Hungary	HU	WINE	
Dunai		Hungary	HU	WINE	
Dunántúl		Hungary	HU	WINE	
Dunántúli		Hungary	HU	WINE	
Duna-Tisza-közi		Hungary	HU	WINE	
Eger		Hungary	HU	WINE	
Egri		Hungary	HU	WINE	
Etyek-Buda		Hungary	HU	WINE	
Etyek-Budai		Hungary	HU	WINE	
Felső-Magyarország		Hungary	HU	WINE	
Felső-Magyarországi		Hungary	HU	WINE	
Hajós-Baja		Hungary	HU	WINE	
Izsáki Arany Sárfehér		Hungary	HU	WINE	
Káli		Hungary	HU	WINE	
Kunság		Hungary	HU	WINE	
Kunsági		Hungary	HU	WINE	
Mátra		Hungary	HU	WINE	

**Avropa İttifaqı ölkələrinin ərazilərində mühafizə olunan  
coğrafi göstəricilərin siyahısı**

**The list of geographical indications that are protected  
within the territory of the European Union countries**

**Список географических указаний, охраняемых  
на территории стран Европейского Союза**

**Bülleten № 2. 28.02.2019**

Mátraí		Hungary	HU	WINE	
Monor		Hungary	HU	WINE	
Monori		Hungary	HU	WINE	
Mór		Hungary	HU	WINE	
Móri		Hungary	HU	WINE	
Nagy-Somló		Hungary	HU	WINE	
Nagy-Somlóí		Hungary	HU	WINE	
Neszmély		Hungary	HU	WINE	
Neszmélyi		Hungary	HU	WINE	
Pannon		Hungary	HU	WINE	
Pannonhalma		Hungary	HU	WINE	
Pannonhalmi		Hungary	HU	WINE	
Pécs		Hungary	HU	WINE	
Somló		Hungary	HU	WINE	
Somlóí		Hungary	HU	WINE	
Sopron		Hungary	HU	WINE	
Soproni		Hungary	HU	WINE	
Szekszárd		Hungary	HU	WINE	
Szekszárdi		Hungary	HU	WINE	
Tihany		Hungary	HU	WINE	
Tihanyi		Hungary	HU	WINE	
Tokaj		Hungary	HU	WINE	
Tokaji		Hungary	HU	WINE	
Tolna		Hungary	HU	WINE	
Tolnai		Hungary	HU	WINE	
Villány		Hungary	HU	WINE	
Villányi		Hungary	HU	WINE	
Zala		Hungary	HU	WINE	
Zalai		Hungary	HU	WINE	
Zemplén		Hungary	HU	WINE	
Zempléni		Hungary	HU	WINE	
Pálinka		Hungary/ Austria	HU/ AT	SPIRITS	Fruit spirit
Clare Island Salmon		Ireland	IE	FOOD	Class 1.7. Fresh fish, molluscs, and crustaceans and products derived therefrom
Connemara Hill Lamb / Uain Sléibhe Chonamara		Ireland	IE	FOOD	Class 1.1. Fresh meat (and offal)
Imokilly Regato		Ireland	IE	FOOD	Class 1.3. Cheeses
Oriel Sea Minerals		Ireland	IE	FOOD	Class 1.8. other products of Annex I of the Treaty (spices etc.)
Oriel Sea Salt		Ireland	IE	FOOD	Class 1.8. other products of Annex I of the Treaty (spices etc.)
Timoleague Brown Pudding		Ireland	IE	FOOD	Class 1.2. Meat products (cooked, salted, smoked, etc.)
Waterford Blaa / Blaa		Ireland	IE	FOOD	Class 2.4. Bread, pastry, cakes, confectionery, biscuits and other baker's wares

**Avropa İttifaqı ölkələrinin ərazilərində mühafizə olunan  
coğrafi göstəricilərin siyahısı**

**The list of geographical indications that are protected  
within the territory of the European Union countries.**

**Список географических указаний, охраняемых  
на территории стран Европейского Союза**

**Bülleten № 2. 28.02.2019**

Irish Poteen/Irish Poitín		Ireland	IE	SPIRITS	Other
Irish Whiskey/Uisce Beatha Eireannach/Irish Whisky		Ireland	IE	SPIRITS	Whisky or Whiskey
Irish Cream		Ireland/Northern Ireland	IE	SPIRITS	Liqueur
Abbacchio Romano		Italy	IT	FOOD	Class 1.1. Fresh meat (and offal)
Acciughe sotto sale del Mar Ligure		Italy	IT	FOOD	Class 1.7. Fresh fish, molluscs, and crustaceans and products derived therefrom
Aceto Balsamico di Modena		Italy	IT	FOOD	Class 1.8. other products of Annex I of the Treaty (spices etc.)
Aceto balsamico tradizionale di Modena		Italy	IT	FOOD	Class 1.8. other products of Annex I of the Treaty (spices etc.)
Aceto balsamico tradizionale di Reggio Emilia		Italy	IT	FOOD	Class 1.8. other products of Annex I of the Treaty (spices etc.)
Aglio Bianco Polesano		Italy	IT	FOOD	Class 1.6. Fruit, vegetables and cereals fresh or processed
Aglio di Voghiera		Italy	IT	FOOD	Class 1.6. Fruit, vegetables and cereals fresh or processed
Agnello del Centro Italia		Italy	IT	FOOD	Class 1.1. Fresh meat (and offal)
Agnello di Sardegna		Italy	IT	FOOD	Class 1.1. Fresh meat (and offal)
Alto Crotonese		Italy	IT	FOOD	Class 1.5. Oils and fats (butter, margarine, oil, etc.)
Amarene Brusche di Modena		Italy	IT	FOOD	Class 1.6. Fruit, vegetables and cereals fresh or processed
Anguria Reggiana		Italy	IT	FOOD	Class 1.6. Fruit, vegetables and cereals fresh or processed
Aprutino Pescarese		Italy	IT	FOOD	Class 1.5. Oils and fats (butter, margarine, oil, etc.)
Arancia del Gargano		Italy	IT	FOOD	Class 1.6. Fruit, vegetables and cereals fresh or processed
Arancia di Ribera		Italy	IT	FOOD	Class 1.6. Fruit, vegetables and cereals fresh or processed
Arancia Rossa di Sicilia		Italy	IT	FOOD	Class 1.6. Fruit, vegetables and cereals fresh or processed
Asiago		Italy	IT	FOOD	Class 1.3. Cheeses
Asparago Bianco di Bassano		Italy	IT	FOOD	Class 1.6. Fruit, vegetables and cereals fresh or processed
Asparago bianco di Cimadolmo		Italy	IT	FOOD	Class 1.6. Fruit, vegetables and cereals fresh or processed
Asparago di Badoere		Italy	IT	FOOD	Class 1.6. Fruit, vegetables and cereals fresh or processed

**Avropa İttifaqı ölkələrinin ərazilərində mühafizə olunan  
coğrafi göstəricilərin siyahısı**

**The list of geographical indications that are protected  
within the territory of the European Union countries**

**Список географических указаний, охраняемых  
на территории стран Европейского Союза**

**Bülleten № 2. 28.02.2019**

Asparago di Cantello		Italy	IT	FOOD	Class 1.6. Fruit, vegetables and cereals fresh or processed
Asparago verde di Altedo		Italy	IT	FOOD	Class 1.6. Fruit, vegetables and cereals fresh or processed
Basilico Genovese		Italy	IT	FOOD	Class 1.6. Fruit, vegetables and cereals fresh or processed
Bergamotto di Reggio Calabria - Olio essenziale		Italy	IT	FOOD	Class 3.2. Essential oils
Bitto		Italy	IT	FOOD	Class 1.3. Cheeses
Bra		Italy	IT	FOOD	Class 1.3. Cheeses
Bresaola della Valtellina		Italy	IT	FOOD	Class 1.2. Meat products (cooked, salted, smoked, etc.)
Brisighella		Italy	IT	FOOD	Class 1.5. Oils and fats (butter, margarine, oil, etc.)
Brovada		Italy	IT	FOOD	Class 1.6. Fruit, vegetables and cereals fresh or processed
Bruzio		Italy	IT	FOOD	Class 1.5. Oils and fats (butter, margarine, oil, etc.)
Burrata di Andria		Italy	IT	FOOD	Class 1.3. Cheeses
Caciocavallo Silano		Italy	IT	FOOD	Class 1.3. Cheeses
Canestrato di Moliterno		Italy	IT	FOOD	Class 1.3. Cheeses
Canestrato Pugliese		Italy	IT	FOOD	Class 1.3. Cheeses
Canino		Italy	IT	FOOD	Class 1.5. Oils and fats (butter, margarine, oil, etc.)
Cantuccini Toscani/Cantucci Toscani		Italy	IT	FOOD	Class 2.4. Bread, pastry, cakes, confectionery, biscuits and other baker's wares
Capocollo di Calabria		Italy	IT	FOOD	Class 1.2. Meat products (cooked, salted, smoked, etc.)
Cappellacci di zucca ferraresi		Italy	IT	FOOD	Class 2.7. Pasta
Cappero di Pantelleria		Italy	IT	FOOD	Class 1.6. Fruit, vegetables and cereals fresh or processed
Carciofo Brindisino		Italy	IT	FOOD	Class 1.6. Fruit, vegetables and cereals fresh or processed
Carciofo di Paestum		Italy	IT	FOOD	Class 1.6. Fruit, vegetables and cereals fresh or processed
Carciofo Romanesco del Lazio		Italy	IT	FOOD	Class 1.6. Fruit, vegetables and cereals fresh or processed
Carciofo Spinoso di Sardegna		Italy	IT	FOOD	Class 1.6. Fruit, vegetables and cereals fresh or processed
Carota dell'Altopiano del Fucino		Italy	IT	FOOD	Class 1.6. Fruit, vegetables and cereals fresh or processed
Carota Novella di Ispica		Italy	IT	FOOD	Class 1.6. Fruit, vegetables and cereals fresh or processed
Cartoceto		Italy	IT	FOOD	Class 1.5. Oils and fats (butter, margarine, oil, etc.)
Caciocavallo Silano		Italy	IT	FOOD	Class 1.3. Cheeses
Casatella Trevigiana		Italy	IT	FOOD	Class 1.3. Cheeses
Casciotta d'Urbino		Italy	IT	FOOD	Class 1.3. Cheeses

**Avropa İttifaqı ölkələrinin ərazilərində mühafizə olunan  
coğrafi göstəricilərin siyahısı**

**The list of geographical indications that are protected  
within the territory of the European Union countries.**

**Список географических указаний, охраняемых  
на территории стран Европейского Союза**

**Bülleten № 2. 28.02.2019**

Castagna Cuneo		Italy	IT	FOOD	Class 1.6. Fruit, vegetables and cereals fresh or processed
Castagna del Monte Amiata		Italy	IT	FOOD	Class 1.6. Fruit, vegetables and cereals fresh or processed
Castagna di Montella		Italy	IT	FOOD	Class 1.6. Fruit, vegetables and cereals fresh or processed
Castagna di Vallerano		Italy	IT	FOOD	Class 1.6. Fruit, vegetables and cereals fresh or processed
Castelmagno		Italy	IT	FOOD	Class 1.3. Cheeses
Chianti Classico		Italy	IT	FOOD	Class 1.5. Oils and fats (butter, margarine, oil, etc.)
Ciauscolo		Italy	IT	FOOD	Class 1.2. Meat products (cooked, salted, smoked, etc.)
Cilento		Italy	IT	FOOD	Class 1.5. Oils and fats (butter, margarine, oil, etc.)
Ciliegia dell'Etna		Italy	IT	FOOD	Class 1.6. Fruit, vegetables and cereals fresh or processed
Ciliegia di Marostica		Italy	IT	FOOD	Class 1.6. Fruit, vegetables and cereals fresh or processed
Ciliegia di Vignola		Italy	IT	FOOD	Class 1.6. Fruit, vegetables and cereals fresh or processed
Cinta Senese		Italy	IT	FOOD	Class 1.1. Fresh meat (and offal)
Cipolla bianca di Margherita		Italy	IT	FOOD	Class 1.6. Fruit, vegetables and cereals fresh or processed
Cipolla Rossa di Tropea Calabria		Italy	IT	FOOD	Class 1.6. Fruit, vegetables and cereals fresh or processed
Cipollotto Nocerino		Italy	IT	FOOD	Class 1.6. Fruit, vegetables and cereals fresh or processed
Clementine del Golfo di Taranto		Italy	IT	FOOD	Class 1.6. Fruit, vegetables and cereals fresh or processed
Clementine di Calabria		Italy	IT	FOOD	Class 1.6. Fruit, vegetables and cereals fresh or processed
Collina di Brindisi		Italy	IT	FOOD	Class 1.5. Oils and fats (butter, margarine, oil, etc.)
Colline di Romagna		Italy	IT	FOOD	Class 1.5. Oils and fats (butter, margarine, oil, etc.)
Colline Pontine		Italy	IT	FOOD	Class 1.5. Oils and fats (butter, margarine, oil, etc.)
Colline Salernitane		Italy	IT	FOOD	Class 1.5. Oils and fats (butter, margarine, oil, etc.)
Colline Teatine		Italy	IT	FOOD	Class 1.5. Oils and fats (butter, margarine, oil, etc.)
Coppa di Parma		Italy	IT	FOOD	Class 1.2. Meat products (cooked, salted, smoked, etc.)
Coppa Piacentina		Italy	IT	FOOD	Class 1.2. Meat products (cooked, salted, smoked, etc.)
Coppia Ferrarese		Italy	IT	FOOD	Class 2.4. Bread, pastry, cakes, confectionery, biscuits and other baker's wares
Cotechino Modena		Italy	IT	FOOD	Class 1.2. Meat products (cooked, salted, smoked, etc.)



**Avropa İttifaqı ölkələrinin ərazilərində mühafizə olunan  
coğrafi göstəricilərin siyahısı**

**The list of geographical indications that are protected  
within the territory of the European Union countries**

**Список географических указаний, охраняемых  
на территории стран Европейского Союза**

**Bülleten № 2. 28.02.2019**

Cozza di Scardovari		Italy	IT	FOOD	Class 1.7. Fresh fish, molluscs, and crustaceans and products derived therefrom
Crudo di Cuneo		Italy	IT	FOOD	Class 1.2. Meat products (cooked, salted, smoked, etc.)
Culatello di Zibello		Italy	IT	FOOD	Class 1.2. Meat products (cooked, salted, smoked, etc.)
Culurgionis d'Ogliastro		Italy	IT	FOOD	Class 2.7. Pasta
Dauno		Italy	IT	FOOD	Class 1.5. Oils and fats (butter, margarine, oil, etc.)
Fagioli Bianchi di Rotonda		Italy	IT	FOOD	Class 1.6. Fruit, vegetables and cereals fresh or processed
Fagiolo Cannellino di Atina		Italy	IT	FOOD	Class 1.6. Fruit, vegetables and cereals fresh or processed
Fagiolo Cuneo		Italy	IT	FOOD	Class 1.6. Fruit, vegetables and cereals fresh or processed
Fagiolo di Lamon della Vallata Bellunese		Italy	IT	FOOD	Class 1.6. Fruit, vegetables and cereals fresh or processed
Fagiolo di Sarconi		Italy	IT	FOOD	Class 1.6. Fruit, vegetables and cereals fresh or processed
Fagiolo di Sorana		Italy	IT	FOOD	Class 1.6. Fruit, vegetables and cereals fresh or processed
Farina di castagne della Lunigiana		Italy	IT	FOOD	Class 1.6. Fruit, vegetables and cereals fresh or processed
Farina di Neccio della Garfagnana		Italy	IT	FOOD	Class 1.6. Fruit, vegetables and cereals fresh or processed
Farro della Garfagnana		Italy	IT	FOOD	Class 1.6. Fruit, vegetables and cereals fresh or processed
Farro di Monteleone di Spoleto		Italy	IT	FOOD	Class 1.6. Fruit, vegetables and cereals fresh or processed
Fichi di Cosenza		Italy	IT	FOOD	Class 1.6. Fruit, vegetables and cereals fresh or processed
Fico Bianco del Cilento		Italy	IT	FOOD	Class 1.6. Fruit, vegetables and cereals fresh or processed
Ficodindia dell'Etna		Italy	IT	FOOD	Class 1.6. Fruit, vegetables and cereals fresh or processed
Ficodindia di San Cono		Italy	IT	FOOD	Class 1.6. Fruit, vegetables and cereals fresh or processed
Finocchiona		Italy	IT	FOOD	Class 1.2. Meat products (cooked, salted, smoked, etc.)
Fiore Sardo		Italy	IT	FOOD	Class 1.3. Cheeses
Focaccia di Recco col formaggio		Italy	IT	FOOD	Class 2.4. Bread, pastry, cakes, confectionery, biscuits and other baker's wares
Fontina		Italy	IT	FOOD	Class 1.3. Cheeses
Formaggella del Luinese		Italy	IT	FOOD	Class 1.3. Cheeses
Formaggio di Fossa di Sogliano		Italy	IT	FOOD	Class 1.3. Cheeses
Formai de Mut dell'Alta Valle Brembana		Italy	IT	FOOD	Class 1.3. Cheeses
Fungo di Borgotaro		Italy	IT	FOOD	Class 1.6. Fruit, vegetables and cereals fresh or processed

**Avropa İttifaqı ölkələrinin ərazilərində mühafizə olunan  
coğrafi göstəricilərin siyahısı**

**The list of geographical indications that are protected  
within the territory of the European Union countries.**

**Список географических указаний, охраняемых  
на территории стран Европейского Союза**

**Bülleten № 2. 28.02.2019**

Garda		Italy	IT	FOOD	Class 1.5. Oils and fats (butter, margarine, oil, etc.)
Gorgonzola		Italy	IT	FOOD	Class 1.3. Cheeses
Grana Padano		Italy	IT	FOOD	Class 1.3. Cheeses
Insalata di Lusia		Italy	IT	FOOD	Class 1.6. Fruit, vegetables and cereals fresh or processed
Irpinia - Colline dell'Ufita		Italy	IT	FOOD	Class 1.5. Oils and fats (butter, margarine, oil, etc.)
Kiwi Latina		Italy	IT	FOOD	Class 1.6. Fruit, vegetables and cereals fresh or processed
La Bella della Daunia		Italy	IT	FOOD	Class 1.6. Fruit, vegetables and cereals fresh or processed
Laghi Lombardi		Italy	IT	FOOD	Class 1.5. Oils and fats (butter, margarine, oil, etc.)
Lametia		Italy	IT	FOOD	Class 1.5. Oils and fats (butter, margarine, oil, etc.)
Lardo di Colonnata		Italy	IT	FOOD	Class 1.2. Meat products (cooked, salted, smoked, etc.)
Lenticchia di Altamura		Italy	IT	FOOD	Class 1.6. Fruit, vegetables and cereals fresh or processed
Lenticchia di Castelluccio di Norcia		Italy	IT	FOOD	Class 1.6. Fruit, vegetables and cereals fresh or processed
Limone Costa d'Amalfi		Italy	IT	FOOD	Class 1.6. Fruit, vegetables and cereals fresh or processed
Limone di Rocca Imperiale		Italy	IT	FOOD	Class 1.6. Fruit, vegetables and cereals fresh or processed
Limone di Siracusa		Italy	IT	FOOD	Class 1.6. Fruit, vegetables and cereals fresh or processed
Limone di Sorrento		Italy	IT	FOOD	Class 1.6. Fruit, vegetables and cereals fresh or processed
Limone Femminello del Gargano		Italy	IT	FOOD	Class 1.6. Fruit, vegetables and cereals fresh or processed
Limone Interdonato Messina		Italy	IT	FOOD	Class 1.6. Fruit, vegetables and cereals fresh or processed
Liquirizia di Calabria		Italy	IT	FOOD	Class 1.8. other products of Annex I of the Treaty (spices etc.)
Lucca		Italy	IT	FOOD	Class 1.5. Oils and fats (butter, margarine, oil, etc.)
Maccheroncini di Campofilone		Italy	IT	FOOD	Class 2.7. Pasta
Marche		Italy	IT	FOOD	Class 1.5. Oils and fats (butter, margarine, oil, etc.)
Marrone del Mugello		Italy	IT	FOOD	Class 1.6. Fruit, vegetables and cereals fresh or processed
Marrone della Valle di Susa		Italy	IT	FOOD	Class 1.6. Fruit, vegetables and cereals fresh or processed
Marrone di Caprese Michelangelo		Italy	IT	FOOD	Class 1.6. Fruit, vegetables and cereals fresh or processed
Marrone di Castel del Rio		Italy	IT	FOOD	Class 1.6. Fruit, vegetables and cereals fresh or processed
Marrone di Combai		Italy	IT	FOOD	Class 1.6. Fruit, vegetables and cereals fresh or processed

**Avropa İttifaqı ölkələrinin ərazilərində mühafizə olunan  
coğrafi göstəricilərin siyahısı**

**The list of geographical indications that are protected  
within the territory of the European Union countries**

**Список географических указаний, охраняемых  
на территории стран Европейского Союза**

**Bülleten № 2. 28.02.2019**

Marrone di Roccadaspide		Italy	IT	FOOD	Class 1.6. Fruit, vegetables and cereals fresh or processed
Marrone di San Zeno		Italy	IT	FOOD	Class 1.6. Fruit, vegetables and cereals fresh or processed
Marroni del Monfenera		Italy	IT	FOOD	Class 1.6. Fruit, vegetables and cereals fresh or processed
Mela Alto Adige / Südtiroler Apfel		Italy	IT	FOOD	Class 1.6. Fruit, vegetables and cereals fresh or processed
Mela di Valtellina		Italy	IT	FOOD	Class 1.6. Fruit, vegetables and cereals fresh or processed
Mela Rossa Cuneo		Italy	IT	FOOD	Class 1.6. Fruit, vegetables and cereals fresh or processed
Mela Val di Non		Italy	IT	FOOD	Class 1.6. Fruit, vegetables and cereals fresh or processed
Melannurca Campana		Italy	IT	FOOD	Class 1.6. Fruit, vegetables and cereals fresh or processed
Melanzana Rossa di Rotonda		Italy	IT	FOOD	Class 1.6. Fruit, vegetables and cereals fresh or processed
Melone Mantovano		Italy	IT	FOOD	Class 1.6. Fruit, vegetables and cereals fresh or processed
Miele della Lunigiana		Italy	IT	FOOD	Class 1.4. Other products of animal origin (eggs, honey, various dairy products except butter, etc.)
Miele delle Dolomiti Bellunesi		Italy	IT	FOOD	Class 1.4. Other products of animal origin (eggs, honey, various dairy products except butter, etc.)
Miele Varesino		Italy	IT	FOOD	Class 1.4. Other products of animal origin (eggs, honey, various dairy products except butter, etc.)
Molise		Italy	IT	FOOD	Class 1.5. Oils and fats (butter, margarine, oil, etc.)
Montasio		Italy	IT	FOOD	Class 1.3. Cheeses
Monte Etna		Italy	IT	FOOD	Class 1.5. Oils and fats (butter, margarine, oil, etc.)
Monte Veronese		Italy	IT	FOOD	Class 1.3. Cheeses
Monti Iblei		Italy	IT	FOOD	Class 1.5. Oils and fats (butter, margarine, oil, etc.)
Mortadella Bologna		Italy	IT	FOOD	Class 1.2. Meat products (cooked, salted, smoked, etc.)
Mortadella di Prato		Italy	IT	FOOD	Class 1.2. Meat products (cooked, salted, smoked, etc.)
Mozzarella di Bufala Campana		Italy	IT	FOOD	Class 1.3. Cheeses
Murazzano		Italy	IT	FOOD	Class 1.3. Cheeses
Nocciola del Piemonte ; Nocciola Piemonte		Italy	IT	FOOD	Class 1.6. Fruit, vegetables and cereals fresh or processed
Nocciola di Giffoni		Italy	IT	FOOD	Class 1.6. Fruit, vegetables and cereals fresh or processed
Nocciola Romana		Italy	IT	FOOD	Class 1.6. Fruit, vegetables and cereals fresh or processed

**Avropa İttifaqı ölkələrinin ərazilərində mühafizə olunan  
coğrafi göstəricilərin siyahısı**

**The list of geographical indications that are protected  
within the territory of the European Union countries.**

**Список географических указаний, охраняемых  
на территории стран Европейского Союза**

**Bülleten № 2. 28.02.2019**

Nocellara del Belice		Italy	IT	FOOD	Class 1.6. Fruit, vegetables and cereals fresh or processed
Nostrano Valtrompia		Italy	IT	FOOD	Class 1.3. Cheeses
Olio di Calabria		Italy	IT	FOOD	Class 1.5. Oils and fats (butter, margarine, oil, etc.)
Oliva Ascolana del Piceno		Italy	IT	FOOD	Class 1.6. Fruit, vegetables and cereals fresh or processed
Oliva di Gaeta		Italy	IT	FOOD	Class 1.6. Fruit, vegetables and cereals fresh or processed
Ossolano		Italy	IT	FOOD	Class 1.3. Cheeses
Pagnotta del Dittaino		Italy	IT	FOOD	Class 2.4. Bread, pastry, cakes, confectionery, biscuits and other baker's wares
Pampapato di Ferrara/Pampepato di Ferrara		Italy	IT	FOOD	Class 2.4. Bread, pastry, cakes, confectionery, biscuits and other baker's wares
Pancetta di Calabria		Italy	IT	FOOD	Class 1.2. Meat products (cooked, salted, smoked, etc.)
Pancetta Piacentina		Italy	IT	FOOD	Class 1.2. Meat products (cooked, salted, smoked, etc.)
Pane casareccio di Genzano		Italy	IT	FOOD	Class 2.4. Bread, pastry, cakes, confectionery, biscuits and other baker's wares
Pane di Altamura		Italy	IT	FOOD	Class 2.4. Bread, pastry, cakes, confectionery, biscuits and other baker's wares
Pane di Matera		Italy	IT	FOOD	Class 2.4. Bread, pastry, cakes, confectionery, biscuits and other baker's wares
Pane Toscano		Italy	IT	FOOD	Class 2.4. Bread, pastry, cakes, confectionery, biscuits and other baker's wares
Panforte di Siena		Italy	IT	FOOD	Class 2.4. Bread, pastry, cakes, confectionery, biscuits and other baker's wares
Parmigiano Reggiano		Italy	IT	FOOD	Class 1.3. Cheeses
Pasta di Gragnano		Italy	IT	FOOD	Class 2.7. Pasta
Patata del Fucino		Italy	IT	FOOD	Class 1.6. Fruit, vegetables and cereals fresh or processed
Patata dell'Alto Viterbese		Italy	IT	FOOD	Class 1.6. Fruit, vegetables and cereals fresh or processed
Patata della Sila		Italy	IT	FOOD	Class 1.6. Fruit, vegetables and cereals fresh or processed
Patata di Bologna		Italy	IT	FOOD	Class 1.6. Fruit, vegetables and cereals fresh or processed
Patata novella di Galatina		Italy	IT	FOOD	Class 1.6. Fruit, vegetables and cereals fresh or processed
Patata Rossa di Colfiorito		Italy	IT	FOOD	Class 1.6. Fruit, vegetables and cereals fresh or processed
Pecorino Crotonese		Italy	IT	FOOD	Class 1.3. Cheeses
Pecorino delle Balze Volterrane		Italy	IT	FOOD	Class 1.3. Cheeses
Pecorino di Filiano		Italy	IT	FOOD	Class 1.3. Cheeses

**Avropa İttifaqı ölkələrinin ərazilərində mühafizə olunan  
coğrafi göstəricilərin siyahısı**

**The list of geographical indications that are protected  
within the territory of the European Union countries**

**Список географических указаний, охраняемых  
на территории стран Европейского Союза**

**Bülleten № 2. 28.02.2019**

Pecorino di Picinisco		Italy	IT	FOOD	Class 1.3. Cheeses
Pecorino Romano		Italy	IT	FOOD	Class 1.3. Cheeses
Pecorino Sardo		Italy	IT	FOOD	Class 1.3. Cheeses
Pecorino Siciliano		Italy	IT	FOOD	Class 1.3. Cheeses
Pecorino Toscano		Italy	IT	FOOD	Class 1.3. Cheeses
Penisola Sorrentina		Italy	IT	FOOD	Class 1.5. Oils and fats (butter, margarine, oil, etc.)
Peperone di Pontecorvo		Italy	IT	FOOD	Class 1.6. Fruit, vegetables and cereals fresh or processed
Peperone di Senise		Italy	IT	FOOD	Class 1.6. Fruit, vegetables and cereals fresh or processed
Pera dell'Emilia Romagna		Italy	IT	FOOD	Class 1.6. Fruit, vegetables and cereals fresh or processed
Pera mantovana		Italy	IT	FOOD	Class 1.6. Fruit, vegetables and cereals fresh or processed
Pesca di Leonforte		Italy	IT	FOOD	Class 1.6. Fruit, vegetables and cereals fresh or processed
Pesca di Verona		Italy	IT	FOOD	Class 1.6. Fruit, vegetables and cereals fresh or processed
Pesca e Nettarina di Romagna		Italy	IT	FOOD	Class 1.6. Fruit, vegetables and cereals fresh or processed
Pescabivona		Italy	IT	FOOD	Class 1.6. Fruit, vegetables and cereals fresh or processed
Piacentinu Ennese		Italy	IT	FOOD	Class 1.3. Cheeses
Piadina Romagnola / Piada Romagnola		Italy	IT	FOOD	Class 2.4. Bread, pastry, cakes, confectionery, biscuits and other baker's wares
Piave		Italy	IT	FOOD	Class 1.3. Cheeses
Pistacchio Verde di Bronte		Italy	IT	FOOD	Class 1.6. Fruit, vegetables and cereals fresh or processed
Pizzoccheri della Valtellina		Italy	IT	FOOD	Class 2.7. Pasta
Pomodorino del Piennolo del Vesuvio		Italy	IT	FOOD	Class 1.6. Fruit, vegetables and cereals fresh or processed
Pomodoro di Pachino		Italy	IT	FOOD	Class 1.6. Fruit, vegetables and cereals fresh or processed
Pomodoro S. Marzano dell'Agro Sarnese-Nocerino		Italy	IT	FOOD	Class 1.6. Fruit, vegetables and cereals fresh or processed
Porchetta di Ariccia		Italy	IT	FOOD	Class 1.2. Meat products (cooked, salted, smoked, etc.)
Pretuziano delle Colline Teramane		Italy	IT	FOOD	Class 1.5. Oils and fats (butter, margarine, oil, etc.)
Prosciutto Amatriciano		Italy	IT	FOOD	Class 1.2. Meat products (cooked, salted, smoked, etc.)
Prosciutto di Carpegna		Italy	IT	FOOD	Class 1.2. Meat products (cooked, salted, smoked, etc.)
Prosciutto di Modena		Italy	IT	FOOD	Class 1.2. Meat products (cooked, salted, smoked, etc.)
Prosciutto di Norcia		Italy	IT	FOOD	Class 1.2. Meat products (cooked, salted, smoked, etc.)
Prosciutto di Parma		Italy	IT	FOOD	Class 1.2. Meat products (cooked, salted, smoked, etc.)

**Avropa İttifaqı ölkələrinin ərazilərində mühafizə olunan  
coğrafi göstəricilərin siyahısı**

**The list of geographical indications that are protected  
within the territory of the European Union countries.**

**Список географических указаний, охраняемых  
на территории стран Европейского Союза**

**Bülleten № 2. 28.02.2019**

Prosciutto di San Daniele		Italy	IT	FOOD	Class 1.2. Meat products (cooked, salted, smoked, etc.)
Prosciutto di Sauris		Italy	IT	FOOD	Class 1.2. Meat products (cooked, salted, smoked, etc.)
Prosciutto Toscano		Italy	IT	FOOD	Class 1.2. Meat products (cooked, salted, smoked, etc.)
Prosciutto Veneto Berico-Euganeo		Italy	IT	FOOD	Class 1.2. Meat products (cooked, salted, smoked, etc.)
Provolone del Monaco		Italy	IT	FOOD	Class 1.3. Cheeses
Provolone Valpadana		Italy	IT	FOOD	Class 1.3. Cheeses
Puzzone di Moena / Spretz Tzaori		Italy	IT	FOOD	Class 1.3. Cheeses
Quartirolo Lombardo		Italy	IT	FOOD	Class 1.3. Cheeses
Radicchio di Chioggia		Italy	IT	FOOD	Class 1.6. Fruit, vegetables and cereals fresh or processed
Radicchio di Verona		Italy	IT	FOOD	Class 1.6. Fruit, vegetables and cereals fresh or processed
Radicchio Rosso di Treviso		Italy	IT	FOOD	Class 1.6. Fruit, vegetables and cereals fresh or processed
Radicchio Variegato di Castelfranco		Italy	IT	FOOD	Class 1.6. Fruit, vegetables and cereals fresh or processed
Ragusano		Italy	IT	FOOD	Class 1.3. Cheeses
Raschera		Italy	IT	FOOD	Class 1.3. Cheeses
Ricciarelli di Siena		Italy	IT	FOOD	Class 2.4. Bread, pastry, cakes, confectionery, biscuits and other baker's wares
Ricotta di Bufala Campana		Italy	IT	FOOD	Class 1.4. Other products of animal origin (eggs, honey, various dairy products except butter, etc.)
Ricotta Romana		Italy	IT	FOOD	Class 1.4. Other products of animal origin (eggs, honey, various dairy products except butter, etc.)
Riso del Delta del Po		Italy	IT	FOOD	Class 1.6. Fruit, vegetables and cereals fresh or processed
Riso di Baraggia Biellese e Vercellese		Italy	IT	FOOD	Class 1.6. Fruit, vegetables and cereals fresh or processed
Riso Nano Vialone Veronese		Italy	IT	FOOD	Class 1.6. Fruit, vegetables and cereals fresh or processed
Riviera Ligure		Italy	IT	FOOD	Class 1.5. Oils and fats (butter, margarine, oil, etc.)
Robiola di Roccaverano		Italy	IT	FOOD	Class 1.3. Cheeses
Sabina		Italy	IT	FOOD	Class 1.5. Oils and fats (butter, margarine, oil, etc.)
Salama da sugo		Italy	IT	FOOD	Class 1.2. Meat products (cooked, salted, smoked, etc.)
Salame Brianza		Italy	IT	FOOD	Class 1.2. Meat products (cooked, salted, smoked, etc.)
Salame Cremona		Italy	IT	FOOD	Class 1.2. Meat products (cooked, salted, smoked, etc.)

**Avropa İttifaqı ölkələrinin ərazilərində mühafizə olunan  
coğrafi göstəricilərin siyahısı**

**The list of geographical indications that are protected  
within the territory of the European Union countries**

**Список географических указаний, охраняемых  
на территории стран Европейского Союза**

**Bülleten № 2. 28.02.2019**

Salame di Varzi		Italy	IT	FOOD	Class 1.2. Meat products (cooked, salted, smoked, etc.)
Salame d'oca di Mortara		Italy	IT	FOOD	Class 1.2. Meat products (cooked, salted, smoked, etc.)
Salame Felino		Italy	IT	FOOD	Class 1.2. Meat products (cooked, salted, smoked, etc.)
Salame Piacentino		Italy	IT	FOOD	Class 1.2. Meat products (cooked, salted, smoked, etc.)
Salame Piemonte		Italy	IT	FOOD	Class 1.2. Meat products (cooked, salted, smoked, etc.)
Salame S. Angelo		Italy	IT	FOOD	Class 1.2. Meat products (cooked, salted, smoked, etc.)
Salamini italiani alla cacciatora		Italy	IT	FOOD	Class 1.2. Meat products (cooked, salted, smoked, etc.)
Sale Marino di Trapani		Italy	IT	FOOD	Class 1.8. other products of Annex I of the Treaty (spices etc.)
Salmerino del Trentino		Italy	IT	FOOD	Class 1.7. Fresh fish, molluscs, and crustaceans and products derived therefrom
Salsiccia di Calabria		Italy	IT	FOOD	Class 1.2. Meat products (cooked, salted, smoked, etc.)
Salva Cremasco		Italy	IT	FOOD	Class 1.3. Cheeses
Sardegna		Italy	IT	FOOD	Class 1.5. Oils and fats (butter, margarine, oil, etc.)
Scalognò di Romagna		Italy	IT	FOOD	Class 1.6. Fruit, vegetables and cereals fresh or processed
Sedano Bianco di Sperlonga		Italy	IT	FOOD	Class 1.6. Fruit, vegetables and cereals fresh or processed
Seggiano		Italy	IT	FOOD	Class 1.5. Oils and fats (butter, margarine, oil, etc.)
Sicilia		Italy	IT	FOOD	Class 1.5. Oils and fats (butter, margarine, oil, etc.)
Silter		Italy	IT	FOOD	Class 1.3. Cheeses
Soppressata di Calabria		Italy	IT	FOOD	Class 1.2. Meat products (cooked, salted, smoked, etc.)
Soprèssa Vicentina		Italy	IT	FOOD	Class 1.2. Meat products (cooked, salted, smoked, etc.)
Speck Alto Adige / Südtiroler Markenspeck / Südtiroler Speck		Italy	IT	FOOD	Class 1.2. Meat products (cooked, salted, smoked, etc.)
Spessa delle Giudicarie		Italy	IT	FOOD	Class 1.3. Cheeses
Squacquerone di Romagna		Italy	IT	FOOD	Class 1.3. Cheeses
Stelvio ; Stilfser		Italy	IT	FOOD	Class 1.3. Cheeses
Strachitunt		Italy	IT	FOOD	Class 1.3. Cheeses
Susina di Dro		Italy	IT	FOOD	Class 1.6. Fruit, vegetables and cereals fresh or processed
Taleggio		Italy	IT	FOOD	Class 1.3. Cheeses
Tergeste		Italy	IT	FOOD	Class 1.5. Oils and fats (butter, margarine, oil, etc.)



**Avropa İttifaqı ölkələrinin ərazilərində mühafizə olunan  
coğrafi göstəricilərin siyahısı**

**The list of geographical indications that are protected  
within the territory of the European Union countries.**

**Список географических указаний, охраняемых  
на территории стран Европейского Союза**

**Bülleten № 2. 28.02.2019**

Terra di Bari		Italy	IT	FOOD	Class 1.5. Oils and fats (butter, margarine, oil, etc.)
Terra d'Otranto		Italy	IT	FOOD	Class 1.5. Oils and fats (butter, margarine, oil, etc.)
Terre Aurunche		Italy	IT	FOOD	Class 1.5. Oils and fats (butter, margarine, oil, etc.)
Terre di Siena		Italy	IT	FOOD	Class 1.5. Oils and fats (butter, margarine, oil, etc.)
Terre Tarentine		Italy	IT	FOOD	Class 1.5. Oils and fats (butter, margarine, oil, etc.)
Tinca Gobba Dorata del Pianalto di Poirino		Italy	IT	FOOD	Class 1.7. Fresh fish, molluscs, and crustaceans and products derived therefrom
Toma Piemontese		Italy	IT	FOOD	Class 1.3. Cheeses
Torrone di Bagnara		Italy	IT	FOOD	Class 2.4. Bread, pastry, cakes, confectionery, biscuits and other baker's wares
Toscano		Italy	IT	FOOD	Class 1.5. Oils and fats (butter, margarine, oil, etc.)
Trote del Trentino		Italy	IT	FOOD	Class 1.7. Fresh fish, molluscs, and crustaceans and products derived therefrom
Tuscia		Italy	IT	FOOD	Class 1.5. Oils and fats (butter, margarine, oil, etc.)
Umbria		Italy	IT	FOOD	Class 1.5. Oils and fats (butter, margarine, oil, etc.)
Uva da tavola di Canicatti		Italy	IT	FOOD	Class 1.6. Fruit, vegetables and cereals fresh or processed
Uva da tavola di Mazzarone		Italy	IT	FOOD	Class 1.6. Fruit, vegetables and cereals fresh or processed
Uva di Puglia		Italy	IT	FOOD	Class 1.6. Fruit, vegetables and cereals fresh or processed
Val di Mazara		Italy	IT	FOOD	Class 1.5. Oils and fats (butter, margarine, oil, etc.)
Valdemone		Italy	IT	FOOD	Class 1.5. Oils and fats (butter, margarine, oil, etc.)
Valle d'Aosta Lard d'Arnad/Vallée d'Aoste Lard d'Arnad		Italy	IT	FOOD	Class 1.2. Meat products (cooked, salted, smoked, etc.)
Valle d'Aosta Fromadzo		Italy	IT	FOOD	Class 1.3. Cheeses
Valle d'Aosta Jambon de Bosses		Italy	IT	FOOD	Class 1.2. Meat products (cooked, salted, smoked, etc.)
Valle del Belice		Italy	IT	FOOD	Class 1.5. Oils and fats (butter, margarine, oil, etc.)
Valli Trapanesi		Italy	IT	FOOD	Class 1.5. Oils and fats (butter, margarine, oil, etc.)
Valtellina Casera		Italy	IT	FOOD	Class 1.3. Cheeses
Vastedda della valle del Belice		Italy	IT	FOOD	Class 1.3. Cheeses
Veneto Valpolicella, Veneto Euganei e		Italy	IT	FOOD	Class 1.5. Oils and fats (butter, margarine, oil, etc.)

**Avropa İttifaqı ölkələrinin ərazilərində mühafizə olunan  
coğrafi göstəricilərin siyahısı**

**The list of geographical indications that are protected  
within the territory of the European Union countries**

**Список географических указаний, охраняемых  
на территории стран Европейского Союза**

**Bülleten № 2. 28.02.2019**

Berici, Veneto del Grappa					
Vitellone bianco dell'Appennino centrale		Italy	IT	FOOD	Class 1.1. Fresh meat (and offal)
Vitelloni Piemontesi della Coscia		Italy	IT	FOOD	Class 1.1. Fresh meat (and offal)
Vulture		Italy	IT	FOOD	Class 1.5. Oils and fats (butter, margarine, oil, etc.)
Zafferano dell'Aquila		Italy	IT	FOOD	Class 1.8. other products of Annex I of the Treaty (spices etc.)
Zafferano di San Gimignano		Italy	IT	FOOD	Class 1.8. other products of Annex I of the Treaty (spices etc.)
Zafferano di Sardegna		Italy	IT	FOOD	Class 1.8. other products of Annex I of the Treaty (spices etc.)
Zampone Modena		Italy	IT	FOOD	Class 1.2. Meat products (cooked, salted, smoked, etc.)
Aprikot trentino/Aprikot del Trentino		Italy	IT	SPIRITS	Fruit spirit
Brandy italiano		Italy	IT	SPIRITS	Brandy or Weinbrand
Distillato di mele trentino/Distillato di mele del Trentino		Italy	IT	SPIRITS	Fruit spirit
Genepi del Piemonte		Italy	IT	SPIRITS	Liqueur
Genepi della Valle d'Aosta		Italy	IT	SPIRITS	Liqueur
Génépi des Alpes/Genepi degli Alpi		Italy	IT	SPIRITS	Liqueur
Genziana trentina/Genziana del Trentino		Italy	IT	SPIRITS	Gentian
Grappa		Italy	IT	SPIRITS	Grape marc spirit or grape marc
Grappa di Barolo		Italy	IT	SPIRITS	Grape marc spirit or grape marc
Grappa di Marsala		Italy	IT	SPIRITS	Grape marc spirit or grape marc
Grappa friulana/Grappa del Friuli		Italy	IT	SPIRITS	Grape marc spirit or grape marc
Grappa lombarda/Grappa di Lombardia		Italy	IT	SPIRITS	Grape marc spirit or grape marc
Grappa piemontese/Grappa del Piemonte		Italy	IT	SPIRITS	Grape marc spirit or grape marc
Grappa siciliana/Grappa di Sicilia		Italy	IT	SPIRITS	Grape marc spirit or grape marc

**Avropa İttifaqı ölkələrinin ərazilərində mühafizə olunan  
coğrafi göstəricilərin siyahısı**

**The list of geographical indications that are protected  
within the territory of the European Union countries.**

**Список географических указаний, охраняемых  
на территории стран Европейского Союза**

**Bülleten № 2. 28.02.2019**

Grappa trentina/Grappa del Trentino		Italy	IT	SPIRITS	Grape marc spirit or grape marc
Grappa veneta/Grappa del Veneto		Italy	IT	SPIRITS	Grape marc spirit or grape marc
Kirsch Friulano/Kirschwasser Friulano		Italy	IT	SPIRITS	Fruit spirit
Kirsch Trentino/Kirschwasser Trentino		Italy	IT	SPIRITS	Fruit spirit
Kirsch Veneto/Kirschwasser Veneto		Italy	IT	SPIRITS	Fruit spirit
Liquore di limone della Costa d'Amalfi		Italy	IT	SPIRITS	Liqueur
Liquore di limone di Sorrento		Italy	IT	SPIRITS	Liqueur
Mirto di Sardegna		Italy	IT	SPIRITS	Liqueur
Nocino di Modena		Italy	IT	SPIRITS	Nocino
Sliwovitz del Friuli-Venezia Giulia		Italy	IT	SPIRITS	Fruit spirit
Sliwovitz del Veneto		Italy	IT	SPIRITS	Fruit spirit
Sliwovitz trentino/Sliwovitz del Trentino		Italy	IT	SPIRITS	Fruit spirit
Südtiroler Enzian/Genziana dell'Alto Adige		Italy	IT	SPIRITS	Gentian
Südtiroler Golden Delicious/Golden Delicious dell'Alto Adige		Italy	IT	SPIRITS	Fruit spirit
Südtiroler Grappa/Grappa dell'Alto Adige		Italy	IT	SPIRITS	Grape marc spirit or grape marc
Südtiroler Gravensteiner/Gravensteiner dell'Alto Adige		Italy	IT	SPIRITS	Fruit spirit
Südtiroler Kirsch/Kirsch dell'Alto Adige		Italy	IT	SPIRITS	Fruit spirit
Südtiroler Marille/Marille dell'Alto Adige		Italy	IT	SPIRITS	Fruit spirit
Südtiroler Obstler/Obstler dell'Alto Adige		Italy	IT	SPIRITS	Fruit spirit
Südtiroler Williams/Williams dell'Alto Adige		Italy	IT	SPIRITS	Fruit spirit

**Avropa İttifaqı ölkələrinin ərazilərində mühafizə olunan  
coğrafi göstəricilərin siyahısı**

**The list of geographical indications that are protected  
within the territory of the European Union countries**

**Список географических указаний, охраняемых  
на территории стран Европейского Союза**

**Bülleten № 2. 28.02.2019**

Südtiroler Zwetschgeler/Zwetsch geler dell'Alto Adige		Italy	IT	SPIRITS	Fruit spirit
Williams friulano/Williams del Friuli		Italy	IT	SPIRITS	Fruit spirit
Williams trentino/Williams del Trentino		Italy	IT	SPIRITS	Fruit spirit
Abruzzo		Italy	IT	WINE	
Acqui		Italy	IT	WINE	
Affile		Italy	IT	WINE	
Aglianico del Taburno		Italy	IT	WINE	
Aglianico del Vulture		Italy	IT	WINE	
Aglianico del Vulture Superiore		Italy	IT	WINE	
Alba		Italy	IT	WINE	
Albugnano		Italy	IT	WINE	
Alcamo		Italy	IT	WINE	
Aleatico di Gradoli		Italy	IT	WINE	
Aleatico di Puglia		Italy	IT	WINE	
Aleatico Passito dell'Elba		Italy	IT	WINE	
Alezio		Italy	IT	WINE	
Alghero		Italy	IT	WINE	
Allerona		Italy	IT	WINE	
Alta Langa		Italy	IT	WINE	
Alta Valle della Greve		Italy	IT	WINE	
Alto Adige		Italy	IT	WINE	
Alto Livenza		Italy	IT	WINE	
Alto Mincio		Italy	IT	WINE	
Amarone della Valpolicella		Italy	IT	WINE	
Amelia		Italy	IT	WINE	
Anagni		Italy	IT	WINE	
Ansonica Costa dell'Argentario		Italy	IT	WINE	
Aprilia		Italy	IT	WINE	
Arborea		Italy	IT	WINE	
Arcole		Italy	IT	WINE	
Arghillà		Italy	IT	WINE	
Asolo - Prosecco		Italy	IT	WINE	
Assisi		Italy	IT	WINE	
Asti		Italy	IT	WINE	
Atina		Italy	IT	WINE	
Aversa		Italy	IT	WINE	
Avola		Italy	IT	WINE	
Bagnoli		Italy	IT	WINE	
Bagnoli di Sopra		Italy	IT	WINE	
Bagnoli Friularo		Italy	IT	WINE	
Barbagia		Italy	IT	WINE	
Barbaresco		Italy	IT	WINE	

**Avropa İttifaqı ölkələrinin ərazilərində mühafizə olunan  
coğrafi göstəricilərin siyahısı**

**The list of geographical indications that are protected  
within the territory of the European Union countries.**

**Список географических указаний, охраняемых  
на территории стран Европейского Союза**

Bülleten № 2. 28.02.2019

Barbera d'Alba		Italy	IT	WINE	
Barbera d'Asti		Italy	IT	WINE	
Barbera del Monferrato		Italy	IT	WINE	
Barbera del Monferrato Superiore		Italy	IT	WINE	
Barco Reale di Carmignano		Italy	IT	WINE	
Bardolino		Italy	IT	WINE	
Bardolino Superiore		Italy	IT	WINE	
Barletta		Italy	IT	WINE	
Barolo		Italy	IT	WINE	
Basilicata		Italy	IT	WINE	
Benaco Bresciano		Italy	IT	WINE	
Beneventano		Italy	IT	WINE	
Benevento		Italy	IT	WINE	
Bergamasca		Italy	IT	WINE	
Bettona		Italy	IT	WINE	
Bianchello del Metauro		Italy	IT	WINE	
Bianco Capena		Italy	IT	WINE	
Bianco del Sillaro		Italy	IT	WINE	
Bianco dell'Empolese		Italy	IT	WINE	
Bianco di Castelfranco Emilia		Italy	IT	WINE	
Bianco di Custoza		Italy	IT	WINE	
Bianco di Pitigliano		Italy	IT	WINE	
Biferno		Italy	IT	WINE	
Bivongi		Italy	IT	WINE	
Boca		Italy	IT	WINE	
Bolgheri		Italy	IT	WINE	
Bolgheri Sassicaia		Italy	IT	WINE	
Bonarda dell'Oltrepò Pavese		Italy	IT	WINE	
Bosco Eliceo		Italy	IT	WINE	
Botticino		Italy	IT	WINE	
Brachetto d'Acqui		Italy	IT	WINE	
Bramaterra		Italy	IT	WINE	
Breganze		Italy	IT	WINE	
Brindisi		Italy	IT	WINE	
Brunello di Montalcino		Italy	IT	WINE	
Buttafuoco		Italy	IT	WINE	
Buttafuoco dell'Oltrepò Pavese		Italy	IT	WINE	
Cacc'e mmitte di Lucera		Italy	IT	WINE	
Cagliari		Italy	IT	WINE	
Calabria		Italy	IT	WINE	
Caldaro		Italy	IT	WINE	
Calosso		Italy	IT	WINE	
Caluso		Italy	IT	WINE	
Camarro		Italy	IT	WINE	
Campania		Italy	IT	WINE	

**Avropa İttifaqı ölkələrinin ərazilərində mühafizə olunan  
coğrafi göstəricilərin siyahısı**

**The list of geographical indications that are protected  
within the territory of the European Union countries**

**Список географических указаний, охраняемых  
на территории стран Европейского Союза**

**Bülleten № 2. 28.02.2019**

Campi Flegrei		Italy	IT	WINE	
Campidano di Terralba		Italy	IT	WINE	
Canavese		Italy	IT	WINE	
Candia dei Colli Apuani		Italy	IT	WINE	
Cannara		Italy	IT	WINE	
Cannellino di Frascati		Italy	IT	WINE	
Cannonau di Sardegna		Italy	IT	WINE	
Capalbio		Italy	IT	WINE	
Capri		Italy	IT	WINE	
Capriano del Colle		Italy	IT	WINE	
Carema		Italy	IT	WINE	
Carignano del Sulcis		Italy	IT	WINE	
Carmignano		Italy	IT	WINE	
Carso		Italy	IT	WINE	
Carso - Kras		Italy	IT	WINE	
Casavecchia di Pontelatone		Italy	IT	WINE	
Casorzo		Italy	IT	WINE	
Casteggio		Italy	IT	WINE	
Castel del Monte		Italy	IT	WINE	
Castel del Monte Bombino Nero		Italy	IT	WINE	
Castel del Monte Nero di Troia Riserva		Italy	IT	WINE	
Castel del Monte Rosso Riserva		Italy	IT	WINE	
Castel San Lorenzo		Italy	IT	WINE	
Casteller		Italy	IT	WINE	
Castelli di Jesi Verdicchio Riserva		Italy	IT	WINE	
Castelli Romani		Italy	IT	WINE	
Catalanesca del Monte Somma		Italy	IT	WINE	
Cellatica		Italy	IT	WINE	
Cerasuolo di Vittoria		Italy	IT	WINE	
Cerveteri		Italy	IT	WINE	
Cesanese del Piglio		Italy	IT	WINE	
Cesanese di Affile		Italy	IT	WINE	
Cesanese di Olevano Romano		Italy	IT	WINE	
Chianti		Italy	IT	WINE	
Chianti Classico		Italy	IT	WINE	
Cilento		Italy	IT	WINE	
Cinque Terre		Italy	IT	WINE	
Cinque Terre Sciacchetrà		Italy	IT	WINE	
Circeo		Italy	IT	WINE	
Cirò		Italy	IT	WINE	
Cisterna d'Asti		Italy	IT	WINE	
Civitella d'Agliano		Italy	IT	WINE	

**Avropa İttifaqı ölkələrinin ərazilərində mühafizə olunan  
coğrafi göstəricilərin siyahısı**

**The list of geographical indications that are protected  
within the territory of the European Union countries.**

**Список географических указаний, охраняемых  
на территории стран Европейского Союза**

Bülleten № 2. 28.02.2019

Colleoni		Italy	IT	WINE	
Colli Albani		Italy	IT	WINE	
Colli Altotiberini		Italy	IT	WINE	
Colli Aprutini		Italy	IT	WINE	
Colli Asolani - Prosecco		Italy	IT	WINE	
Colli Berici		Italy	IT	WINE	
Colli Bolognesi		Italy	IT	WINE	
Colli Bolognesi Classico Pignoletto		Italy	IT	WINE	
Colli Cimini		Italy	IT	WINE	
Colli del Limbara		Italy	IT	WINE	
Colli del Sangro		Italy	IT	WINE	
Colli del Trasimeno		Italy	IT	WINE	
Colli della Sabina		Italy	IT	WINE	
Colli della Toscana centrale		Italy	IT	WINE	
Colli dell'Etruria Centrale		Italy	IT	WINE	
Colli di Conegliano		Italy	IT	WINE	
Colli di Faenza		Italy	IT	WINE	
Colli di Luni		Italy	IT	WINE	
Colli di Parma		Italy	IT	WINE	
Colli di Rimini		Italy	IT	WINE	
Colli di Salerno		Italy	IT	WINE	
Colli di Scandiano e di Canossa		Italy	IT	WINE	
Colli d'Imola		Italy	IT	WINE	
Colli Etruschi Viterbesi		Italy	IT	WINE	
Colli Euganei		Italy	IT	WINE	
Colli Euganei Fior d'Arancio		Italy	IT	WINE	
Colli Lanuvini		Italy	IT	WINE	
Colli Maceratesi		Italy	IT	WINE	
Colli Martani		Italy	IT	WINE	
Colli Orientali del Friuli Picolit		Italy	IT	WINE	
Colli Perugini		Italy	IT	WINE	
Colli Pesaresi		Italy	IT	WINE	
Colli Piacentini		Italy	IT	WINE	
Colli Romagna centrale		Italy	IT	WINE	
Colli Tortonesi		Italy	IT	WINE	
Colli Trevigiani		Italy	IT	WINE	
Collina del Milanese		Italy	IT	WINE	
Collina Torinese		Italy	IT	WINE	
Colline del Genovesato		Italy	IT	WINE	
Colline di Levanto		Italy	IT	WINE	
Colline Frentane		Italy	IT	WINE	
Colline Joniche Tarantine		Italy	IT	WINE	

**Avropa İttifaqı ölkələrinin ərazilərində mühafizə olunan  
coğrafi göstəricilərin siyahısı**

**The list of geographical indications that are protected  
within the territory of the European Union countries**

**Список географических указаний, охраняемых  
на территории стран Европейского Союза**

**Bülleten № 2. 28.02.2019**

Colline Lucchesi		Italy	IT	WINE	
Colline Novaresi		Italy	IT	WINE	
Colline Pescaresi		Italy	IT	WINE	
Colline Saluzzesi		Italy	IT	WINE	
Colline Savonesi		Italy	IT	WINE	
Colline Teatine		Italy	IT	WINE	
Collio		Italy	IT	WINE	
Collio Goriziano		Italy	IT	WINE	
Colonna		Italy	IT	WINE	
Conegliano - Prosecco		Italy	IT	WINE	
Conegliano Valdobbiadene - Prosecco		Italy	IT	WINE	
Cònero		Italy	IT	WINE	
Conselvano		Italy	IT	WINE	
Contea di Sclafani		Italy	IT	WINE	
Contessa Entellina		Italy	IT	WINE	
Controguerra		Italy	IT	WINE	
Copertino		Italy	IT	WINE	
Cori		Italy	IT	WINE	
Cortese dell'Alto Monferrato		Italy	IT	WINE	
Cortese di Gavi		Italy	IT	WINE	
Corti Benedettine del Padovano		Italy	IT	WINE	
Cortona		Italy	IT	WINE	
Costa d'Amalfi		Italy	IT	WINE	
Costa Etrusco Romana		Italy	IT	WINE	
Costa Toscana		Italy	IT	WINE	
Costa Viola		Italy	IT	WINE	
Coste della Sesia		Italy	IT	WINE	
Curtefranca		Italy	IT	WINE	
Custoza		Italy	IT	WINE	
Daunia		Italy	IT	WINE	
del Frusinate		Italy	IT	WINE	
del Molise		Italy	IT	WINE	
del Vastese		Italy	IT	WINE	
Delia Nivolelli		Italy	IT	WINE	
dell'Alto Adige		Italy	IT	WINE	
delle Venezie		Italy	IT	WINE	
dell'Emilia		Italy	IT	WINE	
di Modena		Italy	IT	WINE	
Diano d'Alba		Italy	IT	WINE	
Dogliani		Italy	IT	WINE	
Dolceacqua		Italy	IT	WINE	
Dolcetto d'Acqui		Italy	IT	WINE	
Dolcetto d'Alba		Italy	IT	WINE	
Dolcetto d'Asti		Italy	IT	WINE	
Dolcetto di Diano d'Alba		Italy	IT	WINE	
Dolcetto di Ovada		Italy	IT	WINE	



**Avropa İttifaqı ölkələrinin ərazilərində mühafizə olunan  
coğrafi göstəricilərin siyahısı**

**The list of geographical indications that are protected  
within the territory of the European Union countries.**

**Список географических указаний, охраняемых  
на территории стран Европейского Союза**

Bülleten № 2. 28.02.2019

Dolcetto di Ovada Superiore		Italy	IT	WINE	
Dugenta		Italy	IT	WINE	
Durello Lessini		Italy	IT	WINE	
Elba		Italy	IT	WINE	
Elba Aleatico Passito		Italy	IT	WINE	
Eloro		Italy	IT	WINE	
Emilia		Italy	IT	WINE	
Epomeo		Italy	IT	WINE	
Erbaluce di Caluso		Italy	IT	WINE	
Erice		Italy	IT	WINE	
Esino		Italy	IT	WINE	
Est! Est!! Est!!! di Montefiascone		Italy	IT	WINE	
Etna		Italy	IT	WINE	
Etschtaler		Italy	IT	WINE	
Falanghina del Sannio		Italy	IT	WINE	
Falerio		Italy	IT	WINE	
Falerno del Massico		Italy	IT	WINE	
Fara		Italy	IT	WINE	
Faro		Italy	IT	WINE	
Fiano di Avellino		Italy	IT	WINE	
Fior d'Arancio Colli Euganei		Italy	IT	WINE	
Fontanarossa di Cerda		Italy	IT	WINE	
Forlì		Italy	IT	WINE	
Fortana del Taro		Italy	IT	WINE	
Franciacorta		Italy	IT	WINE	
Frascati		Italy	IT	WINE	
Frascati Superiore		Italy	IT	WINE	
Freisa d'Asti		Italy	IT	WINE	
Freisa di Chieri		Italy	IT	WINE	
Friularo di Bagnoli		Italy	IT	WINE	
Friuli Annia		Italy	IT	WINE	
Friuli Aquileia		Italy	IT	WINE	
Friuli Colli Orientali		Italy	IT	WINE	
Friuli Grave		Italy	IT	WINE	
Friuli Isonzo		Italy	IT	WINE	
Friuli Latisana		Italy	IT	WINE	
Frusinate		Italy	IT	WINE	
Gabiano		Italy	IT	WINE	
Galatina		Italy	IT	WINE	
Galluccio		Italy	IT	WINE	
Gambellara		Italy	IT	WINE	
Garda		Italy	IT	WINE	
Garda Bresciano		Italy	IT	WINE	
Garda Colli Mantovani		Italy	IT	WINE	
Gattinara		Italy	IT	WINE	
Gavi		Italy	IT	WINE	
Genazzano		Italy	IT	WINE	
Ghemme		Italy	IT	WINE	
Gioia del Colle		Italy	IT	WINE	

**Avropa İttifaqı ölkələrinin ərazilərində mühafizə olunan  
coğrafi göstəricilərin siyahısı**

**The list of geographical indications that are protected  
within the territory of the European Union countries**

**Список географических указаний, охраняемых  
на территории стран Европейского Союза**

**Bülleten № 2. 28.02.2019**

Girò di Cagliari		Italy	IT	WINE	
Golfo del Tigullio - Portofino		Italy	IT	WINE	
Grance Senesi		Italy	IT	WINE	
Gravina		Italy	IT	WINE	
Greco di Bianco		Italy	IT	WINE	
Greco di Tufo		Italy	IT	WINE	
Grignolino d'Asti		Italy	IT	WINE	
Grignolino del Monferrato Casalese		Italy	IT	WINE	
Grottino di Roccanova		Italy	IT	WINE	
Gutturnio		Italy	IT	WINE	
Histonium		Italy	IT	WINE	
I Terreni di Sanseverino		Italy	IT	WINE	
Irpinia		Italy	IT	WINE	
Ischia		Italy	IT	WINE	
Isola dei Nuraghi		Italy	IT	WINE	
Isonzo del Friuli		Italy	IT	WINE	
Kalterer		Italy	IT	WINE	
Kalterersee		Italy	IT	WINE	
Lacrima di Morro		Italy	IT	WINE	
Lacrima di Morro d'Alba		Italy	IT	WINE	
Lago di Caldaro		Italy	IT	WINE	
Lago di Corbara		Italy	IT	WINE	
Lambrusco di Sorbara		Italy	IT	WINE	
Lambrusco Grasparossa di Castelvetro		Italy	IT	WINE	
Lambrusco Mantovano		Italy	IT	WINE	
Lambrusco Salamino di Santa Croce		Italy	IT	WINE	
Lamezia		Italy	IT	WINE	
Langhe		Italy	IT	WINE	
Lazio		Italy	IT	WINE	
Lessini Durello		Italy	IT	WINE	
Lessona		Italy	IT	WINE	
Leverano		Italy	IT	WINE	
Liguria di Levante		Italy	IT	WINE	
Lipuda		Italy	IT	WINE	
Lison		Italy	IT	WINE	
Lison-Pramaggiore		Italy	IT	WINE	
Lizzano		Italy	IT	WINE	
Loazzolo		Italy	IT	WINE	
Locorotondo		Italy	IT	WINE	
Locride		Italy	IT	WINE	
Lugana		Italy	IT	WINE	
Malanotte del Piave		Italy	IT	WINE	
Malvasia delle Lipari		Italy	IT	WINE	
Malvasia di Bosa		Italy	IT	WINE	
Malvasia di Casorzo		Italy	IT	WINE	

**Avropa İttifaqı ölkələrinin ərazilərində mühafizə olunan  
coğrafi göstəricilərin siyahısı**

**The list of geographical indications that are protected  
within the territory of the European Union countries.**

**Список географических указаний, охраняемых  
на территории стран Европейского Союза**

Bülleten № 2. 28.02.2019

Malvasia di Casorzo d'Asti		Italy	IT	WINE	
Malvasia di Castelnuovo Don Bosco		Italy	IT	WINE	
Mamertino		Italy	IT	WINE	
Mamertino di Milazzo		Italy	IT	WINE	
Mandrolisai		Italy	IT	WINE	
Marca Trevigiana		Italy	IT	WINE	
Marche		Italy	IT	WINE	
Maremma toscana		Italy	IT	WINE	
Marino		Italy	IT	WINE	
Marmilla		Italy	IT	WINE	
Marsala		Italy	IT	WINE	
Martina		Italy	IT	WINE	
Martina Franca		Italy	IT	WINE	
Matera		Italy	IT	WINE	
Matino		Italy	IT	WINE	
Melissa		Italy	IT	WINE	
Menfi		Italy	IT	WINE	
Merlara		Italy	IT	WINE	
Mitterberg		Italy	IT	WINE	
Modena		Italy	IT	WINE	
Molise		Italy	IT	WINE	
Monferrato		Italy	IT	WINE	
Monica di Sardegna		Italy	IT	WINE	
Monreale		Italy	IT	WINE	
Montecarlo		Italy	IT	WINE	
Montecastelli		Italy	IT	WINE	
Montecompati		Italy	IT	WINE	
Montecompati Colonna		Italy	IT	WINE	
Montecucco		Italy	IT	WINE	
Montecucco Sangiovese		Italy	IT	WINE	
Montefalco		Italy	IT	WINE	
Montefalco Sagrantino		Italy	IT	WINE	
Montello		Italy	IT	WINE	
Montello - Colli Asolani		Italy	IT	WINE	
Montello Rosso		Italy	IT	WINE	
Montenetto di Brescia		Italy	IT	WINE	
Montepulciano d'Abruzzo		Italy	IT	WINE	
Montepulciano d'Abruzzo Colline Teramane		Italy	IT	WINE	
Monteregio di Massa Marittima		Italy	IT	WINE	
Montescudaio		Italy	IT	WINE	
Monti Lessini		Italy	IT	WINE	
Morellino di Scansano		Italy	IT	WINE	

**Avropa İttifaqı ölkələrinin ərazilərində mühafizə olunan  
coğrafi göstəricilərin siyahısı**

**The list of geographical indications that are protected  
within the territory of the European Union countries**

**Список географических указаний, охраняемых  
на территории стран Европейского Союза**

**Bülleten № 2. 28.02.2019**

Moscadello di Montalcino		Italy	IT	WINE	
Moscato di Pantelleria		Italy	IT	WINE	
Moscato di Sardegna		Italy	IT	WINE	
Moscato di Scanzo		Italy	IT	WINE	
Moscato di Sennori		Italy	IT	WINE	
Moscato di Sorso		Italy	IT	WINE	
Moscato di Sorso - Sennori		Italy	IT	WINE	
Moscato di Terracina		Italy	IT	WINE	
Moscato di Trani		Italy	IT	WINE	
Murgia		Italy	IT	WINE	
Nardò		Italy	IT	WINE	
Narni		Italy	IT	WINE	
Nasco di Cagliari		Italy	IT	WINE	
Nebbiolo d'Alba		Italy	IT	WINE	
Negroamaro di Terra d'Otranto		Italy	IT	WINE	
Nettuno		Italy	IT	WINE	
Noto		Italy	IT	WINE	
Nuragus di Cagliari		Italy	IT	WINE	
Nurra		Italy	IT	WINE	
Offida		Italy	IT	WINE	
Ogliastra		Italy	IT	WINE	
Olevano Romano		Italy	IT	WINE	
Oltrepò Pavese		Italy	IT	WINE	
Oltrepò Pavese metodo classico		Italy	IT	WINE	
Oltrepò Pavese Pinot grigio		Italy	IT	WINE	
Orcia		Italy	IT	WINE	
Ormeasco di Pornassio		Italy	IT	WINE	
Orta Nova		Italy	IT	WINE	
Ortona		Italy	IT	WINE	
Ortrugo		Italy	IT	WINE	
Orvietano Rosso		Italy	IT	WINE	
Orvieto		Italy	IT	WINE	
Osco		Italy	IT	WINE	
Ostuni		Italy	IT	WINE	
Ovada		Italy	IT	WINE	
Paestum		Italy	IT	WINE	
Palizzi		Italy	IT	WINE	
Pantelleria		Italy	IT	WINE	
Parrina		Italy	IT	WINE	
Parteolla		Italy	IT	WINE	
Passito di Pantelleria		Italy	IT	WINE	
Pellaro		Italy	IT	WINE	
Penisola Sorrentina		Italy	IT	WINE	
Pentro		Italy	IT	WINE	
Pentro di Isernia		Italy	IT	WINE	
Pergola		Italy	IT	WINE	

**Avropa İttifaqı ölkələrinin ərazilərində mühafizə olunan  
coğrafi göstəricilərin siyahısı**

**The list of geographical indications that are protected  
within the territory of the European Union countries.**

**Список географических указаний, охраняемых  
на территории стран Европейского Союза**

Bülleten № 2. 28.02.2019

Piave		Italy	IT	WINE	
Piave Malanotte		Italy	IT	WINE	
Piceno		Italy	IT	WINE	
Piemonte		Italy	IT	WINE	
Piglio		Italy	IT	WINE	
Pinerolese		Italy	IT	WINE	
Pinot nero dell'Oltrepò Pavese		Italy	IT	WINE	
Planargia		Italy	IT	WINE	
Pomino		Italy	IT	WINE	
Pompeiano		Italy	IT	WINE	
Pornassio		Italy	IT	WINE	
Portofino		Italy	IT	WINE	
Primitivo di Manduria		Italy	IT	WINE	
Primitivo di Manduria Dolce Naturale		Italy	IT	WINE	
Prosecco		Italy	IT	WINE	
Provincia di Mantova		Italy	IT	WINE	
Provincia di Nuoro		Italy	IT	WINE	
Provincia di Pavia		Italy	IT	WINE	
Provincia di Verona		Italy	IT	WINE	
Puglia		Italy	IT	WINE	
Quistello		Italy	IT	WINE	
Ramandolo		Italy	IT	WINE	
Ravenna		Italy	IT	WINE	
Recioto della Valpolicella		Italy	IT	WINE	
Recioto di Gambellara		Italy	IT	WINE	
Recioto di Soave		Italy	IT	WINE	
Riesi		Italy	IT	WINE	
Riviera del Brenta		Italy	IT	WINE	
Riviera del Garda Bresciano		Italy	IT	WINE	
Riviera ligure di Ponente		Italy	IT	WINE	
Roccamonfina		Italy	IT	WINE	
Roero		Italy	IT	WINE	
Roma		Italy	IT	WINE	
Romagna		Italy	IT	WINE	
Romagna Albana		Italy	IT	WINE	
Romangia		Italy	IT	WINE	
Ronchi di Brescia		Italy	IT	WINE	
Ronchi Varesini		Italy	IT	WINE	
Rosazzo		Italy	IT	WINE	
Rossese di Dolceacqua		Italy	IT	WINE	
Rosso Cònero		Italy	IT	WINE	
Rosso della Val di Cornia		Italy	IT	WINE	
Rosso di Cerignola		Italy	IT	WINE	
Rosso di Montalcino		Italy	IT	WINE	

**Avropa İttifaqı ölkələrinin ərazilərində mühafizə olunan  
coğrafi göstəricilərin siyahısı**

**The list of geographical indications that are protected  
within the territory of the European Union countries**

**Список географических указаний, охраняемых  
на территории стран Европейского Союза**

**Bülleten № 2. 28.02.2019**

Rosso di Montepulciano		Italy	IT	WINE	
Rosso di Valtellina		Italy	IT	WINE	
Rosso Orvietano		Italy	IT	WINE	
Rosso Piceno		Italy	IT	WINE	
Rotae		Italy	IT	WINE	
Rubicone		Italy	IT	WINE	
Rubino di Cantavenna		Italy	IT	WINE	
Ruchè di Castagnole Monferrato		Italy	IT	WINE	
S. Anna di Isola Capo Rizzuto		Italy	IT	WINE	
Sabbioneta		Italy	IT	WINE	
Salaparuta		Italy	IT	WINE	
Salemi		Italy	IT	WINE	
Salento		Italy	IT	WINE	
Salice Salentino		Italy	IT	WINE	
Salina		Italy	IT	WINE	
Sambuca di Sicilia		Italy	IT	WINE	
San Colombano		Italy	IT	WINE	
San Colombano al Lambro		Italy	IT	WINE	
San Gimignano		Italy	IT	WINE	
San Ginesio		Italy	IT	WINE	
San Martino della Battaglia		Italy	IT	WINE	
San Severo		Italy	IT	WINE	
San Torpè		Italy	IT	WINE	
Sangue di Giuda		Italy	IT	WINE	
Sangue di Giuda dell'Oltrepò Pavese		Italy	IT	WINE	
Sannio		Italy	IT	WINE	
Santa Margherita di Belice		Italy	IT	WINE	
Sant'Antimo		Italy	IT	WINE	
Sardegna Semidano		Italy	IT	WINE	
Savuto		Italy	IT	WINE	
Scanzo		Italy	IT	WINE	
Scavigna		Italy	IT	WINE	
Sciacca		Italy	IT	WINE	
Scilla		Italy	IT	WINE	
Sebino		Italy	IT	WINE	
Serenissima		Italy	IT	WINE	
Serrapetrona		Italy	IT	WINE	
Sforzato di Valtellina		Italy	IT	WINE	
Sfursat di Valtellina		Italy	IT	WINE	
Sibiola		Italy	IT	WINE	
Sicilia		Italy	IT	WINE	
Sillaro		Italy	IT	WINE	
Siracusa		Italy	IT	WINE	
Sizzano		Italy	IT	WINE	
Soave		Italy	IT	WINE	

**Avropa İttifaqı ölkələrinin ərazilərində mühafizə olunan  
coğrafi göstəricilərin siyahısı**

**The list of geographical indications that are protected  
within the territory of the European Union countries.**

**Список географических указаний, охраняемых  
на территории стран Европейского Союза**

Bülleten № 2. 28.02.2019

Soave Superiore		Italy	IT	WINE	
Sovana		Italy	IT	WINE	
Spello		Italy	IT	WINE	
Spoletto		Italy	IT	WINE	
Squinzano		Italy	IT	WINE	
Strevi		Italy	IT	WINE	
Südtirol		Italy	IT	WINE	
Südtiroler		Italy	IT	WINE	
Suvereto		Italy	IT	WINE	
Tarantino		Italy	IT	WINE	
Tarquinoa		Italy	IT	WINE	
Taurasi		Italy	IT	WINE	
Tavoliere		Italy	IT	WINE	
Tavoliere delle Puglie		Italy	IT	WINE	
Teroldego Rotaliano		Italy	IT	WINE	
Terra d'Otranto		Italy	IT	WINE	
Terracina		Italy	IT	WINE	
Terradeiforti		Italy	IT	WINE	
Terralba		Italy	IT	WINE	
Terratico di Bibbona		Italy	IT	WINE	
Terrazze dell'Imperiese		Italy	IT	WINE	
Terrazze Retiche di Sondrio		Italy	IT	WINE	
Terre Alfieri		Italy	IT	WINE	
Terre Aquilane		Italy	IT	WINE	
Terre de L'Aquila		Italy	IT	WINE	
Terre degli Osci		Italy	IT	WINE	
Terre del Colleoni		Italy	IT	WINE	
Terre del Volturno		Italy	IT	WINE	
Terre dell'Alta Val d'Agri		Italy	IT	WINE	
Terre di Casole		Italy	IT	WINE	
Terre di Chieti		Italy	IT	WINE	
Terre di Cosenza		Italy	IT	WINE	
Terre di Offida		Italy	IT	WINE	
Terre di Pisa		Italy	IT	WINE	
Terre di Veleja		Italy	IT	WINE	
Terre Lariane		Italy	IT	WINE	
Terre Siciliane		Italy	IT	WINE	
Terre Tollesi		Italy	IT	WINE	
Tharros		Italy	IT	WINE	
Tintilia del Molise		Italy	IT	WINE	
Todi		Italy	IT	WINE	
Torgiano		Italy	IT	WINE	
Torgiano Rosso Riserva		Italy	IT	WINE	
Toscana		Italy	IT	WINE	
Toscano		Italy	IT	WINE	
Trasimeno		Italy	IT	WINE	
Trebbiano d'Abruzzo		Italy	IT	WINE	
Trentino		Italy	IT	WINE	

**Avropa İttifaqı ölkələrinin ərazilərində mühafizə olunan  
coğrafi göstəricilərin siyahısı**

**The list of geographical indications that are protected  
within the territory of the European Union countries**

**Список географических указаний, охраняемых  
на территории стран Европейского Союза**

**Bülleten № 2. 28.02.2019**

Trento		Italy	IT	WINE	
Trexenta		Italy	IT	WINE	
Tullum		Italy	IT	WINE	
Tuscia		Italy	IT	WINE	
Umbria		Italy	IT	WINE	
Val d'Arbia		Italy	IT	WINE	
Val d'Arno di Sopra		Italy	IT	WINE	
Val di Cornia		Italy	IT	WINE	
Val di Cornia Rosso		Italy	IT	WINE	
Val di Magra		Italy	IT	WINE	
Val di Neto		Italy	IT	WINE	
Val Polcèvera		Italy	IT	WINE	
Val Tidone		Italy	IT	WINE	
Valcalepio		Italy	IT	WINE	
Valcamonica		Italy	IT	WINE	
Valdadige		Italy	IT	WINE	
Valdadige Terradeiforti		Italy	IT	WINE	
Valdamato		Italy	IT	WINE	
Valdarno di Sopra		Italy	IT	WINE	
Valdichiana toscana		Italy	IT	WINE	
Valdinievole		Italy	IT	WINE	
Valdobbiadene - Prosecco		Italy	IT	WINE	
Vallagarina		Italy	IT	WINE	
Valle Belice		Italy	IT	WINE	
Valle d'Aosta		Italy	IT	WINE	
Valle del Tirso		Italy	IT	WINE	
Valle d'Itria		Italy	IT	WINE	
Vallée d'Aoste		Italy	IT	WINE	
Valli di Porto Pino		Italy	IT	WINE	
Valli Ossolane		Italy	IT	WINE	
Valpolicella		Italy	IT	WINE	
Valpolicella Ripasso		Italy	IT	WINE	
Valsusa		Italy	IT	WINE	
Valtellina rosso		Italy	IT	WINE	
Valtellina Superiore		Italy	IT	WINE	
Valtènesi		Italy	IT	WINE	
Velletri		Italy	IT	WINE	
Veneto		Italy	IT	WINE	
Veneto Orientale		Italy	IT	WINE	
Venezia		Italy	IT	WINE	
Venezia Giulia		Italy	IT	WINE	
Verdicchio dei Castelli di Jesi		Italy	IT	WINE	
Verdicchio di Matelica		Italy	IT	WINE	
Verdicchio di Matelica Riserva		Italy	IT	WINE	
Verduno		Italy	IT	WINE	
Verduno Pelaverga		Italy	IT	WINE	
Vermentino di Gallura		Italy	IT	WINE	
Vermentino di Sardegna		Italy	IT	WINE	



**Avropa İttifaqı ölkələrinin ərazilərində mühafizə olunan  
coğrafi göstəricilərin siyahısı**

**The list of geographical indications that are protected  
within the territory of the European Union countries.**

**Список географических указаний, охраняемых  
на территории стран Европейского Союза**

Bülleten № 2. 28.02.2019

Vernaccia di Oristano		Italy	IT	WINE	
Vernaccia di San Gimignano		Italy	IT	WINE	
Vernaccia di Serrapetrona		Italy	IT	WINE	
Verona		Italy	IT	WINE	
Veronese		Italy	IT	WINE	
Vesuvio		Italy	IT	WINE	
Vicenza		Italy	IT	WINE	
Vignanello		Italy	IT	WINE	
Vigneti della Serenissima		Italy	IT	WINE	
Vigneti delle Dolomiti		Italy	IT	WINE	
Villamagna		Italy	IT	WINE	
Vin Santo del Chianti		Italy	IT	WINE	
Vin Santo del Chianti Classico		Italy	IT	WINE	
Vin Santo di Carmignano		Italy	IT	WINE	
Vin Santo di Montepulciano		Italy	IT	WINE	
Vino Nobile di Montepulciano		Italy	IT	WINE	
Vittoria		Italy	IT	WINE	
Weinberg Dolomiten		Italy	IT	WINE	
Zagarolo		Italy	IT	WINE	
Carnikavas nēgi		Latvia	LV	FOOD	Class 1.7. Fresh fish, molluscs, and crustaceans and products derived therefrom
Latvijas lielie pelēkie zirņi		Latvia	LV	FOOD	Class 1.6. Fruit, vegetables and cereals fresh or processed
Daujėnų naminė duona		Lithuania	LT	FOOD	Class 2.4. Bread, pastry, cakes, confectionery, biscuits and other baker's wares
Lietuviškas varškės sūris		Lithuania	LT	FOOD	Class 1.3. Cheeses
Liliputas		Lithuania	LT	FOOD	Class 1.3. Cheeses
Seinų / Lazdijų krašto medus / Miód z Sejneńszczyzny / Łódziejszczyzny		Lithuania	LT	FOOD	Class 1.4. Other products of animal origin (eggs, honey, various dairy products except butter, etc.)
Stakliškės		Lithuania	LT	FOOD	Class 1.8. other products of Annex I of the Treaty (spices etc.)
Originali lietuviška degtinė/Original Lithuanian vodka		Lithuania	LT	SPIRITS	Vodka
Originali lietuviška degtinė/Original Lithuanian vodka		Lithuania	LT	SPIRITS	Flavoured vodka
Samanė		Lithuania	LT	SPIRITS	Grain spirit
Trauktinė		Lithuania	LT	SPIRITS	Other
Trauktinė Dainava		Lithuania	LT	SPIRITS	Other

**Avropa İttifaqı ölkələrinin ərazilərində mühafizə olunan  
coğrafi göstəricilərin siyahısı**

**The list of geographical indications that are protected  
within the territory of the European Union countries**

**Список географических указаний, охраняемых  
на территории стран Европейского Союза**

**Bülleten № 2. 28.02.2019**

Trauktinė Palanga		Lithuania	LT	SPIRITS	Other
Trejos devynerios		Lithuania	LT	SPIRITS	Bitter-tasting spirit drinks or bitter
Vilniaus Džinas/Vilnius Gin		Lithuania	LT	SPIRITS	Juniper-flavoured spirit drinks
Moselle Luxembourgeoise		Luxembo urg	LU	WINE	
Beurre rose - Marque Nationale du Grand- Duché de Luxembourg		Luxembur g	LU	FOOD	Class 1.5. Oils and fats (butter, margarine, oil, etc.)
Miel - Marque nationale du Grand- Duché de Luxembourg		Luxembur g	LU	FOOD	Class 1.4. Other products of animal origin (eggs, honey, various dairy products except butter, etc.)
Salaisons fumées, marque nationale grand-duché de Luxembourg		Luxembur g	LU	FOOD	Class 1.2. Meat products (cooked, salted, smoked, etc.)
Viande de porc, marque nationale grand-duché de Luxembourg		Luxembur g	LU	FOOD	Class 1.1. Fresh meat (and offal)
Għawdex		Malta	MT	WINE	
Gozo		Malta	MT	WINE	
Malta		Malta	MT	WINE	
Maltese Islands		Malta	MT	WINE	
Boeren-Leidse met sleutels		Netherlan ds	NL	FOOD	Class 1.3. Cheeses
Brabantse Wal asperges		Netherlan ds	NL	FOOD	Class 1.6. Fruit, vegetables and cereals fresh or processed
De Meerlander		Netherlan ds	NL	FOOD	Class 1.6. Fruit, vegetables and cereals fresh or processed
Edam Holland		Netherlan ds	NL	FOOD	Class 1.3. Cheeses
Gouda Holland		Netherlan ds	NL	FOOD	Class 1.3. Cheeses
Hollandse geitenkaas		Netherlan ds	NL	FOOD	Class 1.3. Cheeses
Kanterkaas ; Kanternagelkaas ; Kanterkomijnekaas		Netherlan ds	NL	FOOD	Class 1.3. Cheeses
Noord-Hollandse Edammer		Netherlan ds	NL	FOOD	Class 1.3. Cheeses
Noord-Hollandse Gouda		Netherlan ds	NL	FOOD	Class 1.3. Cheeses
Opperdoezer Ronde		Netherlan ds	NL	FOOD	Class 1.6. Fruit, vegetables and cereals fresh or processed
Westlandse druif		Netherlan ds	NL	FOOD	Class 1.6. Fruit, vegetables and cereals fresh or processed
Drenthe		Netherlan ds	NL	WINE	
Flevoland		Netherlan ds	NL	WINE	

**Avropa İttifaqı ölkələrinin ərazilərində mühafizə olunan  
coğrafi göstəricilərin siyahısı**

**The list of geographical indications that are protected  
within the territory of the European Union countries.**

**Список географических указаний, охраняемых  
на территории стран Европейского Союза**

**Bülleten № 2. 28.02.2019**

Friesland		Netherlan ds	NL	WINE	
Gelderland		Netherlan ds	NL	WINE	
Groningen		Netherlan ds	NL	WINE	
Limburg		Netherlan ds	NL	WINE	
Maasvallei Limburg		Netherlan ds	NL	WINE	
Mergelland		Netherlan ds	NL	WINE	
Noord-Brabant		Netherlan ds	NL	WINE	
Noord-Holland		Netherlan ds	NL	WINE	
Overijssel		Netherlan ds	NL	WINE	
Utrecht		Netherlan ds	NL	WINE	
Zeeland		Netherlan ds	NL	WINE	
Zuid-Holland		Netherlan ds	NL	WINE	
Jonge jenever, jonge genever		Netherlan ds/Belgiu m	NL/B E	SPIRITS	Juniper-flavoured spirit drinks
Oude jenever, oude genever		Netherlan ds/Belgiu m	NL/B E	SPIRITS	Juniper-flavoured spirit drinks
Genièvre de grains, Graanjenever, Graangenever		Netherlan ds/France /Belgium	NL/F R/BE	SPIRITS	Juniper-flavoured spirit drinks
Genièvre aux fruits/Vruchtenjenever/ Jenever met vruchten/Fruchtgeneve r		Netherlan ds/Germa ny/France /Belgium	NL/D E/FR /BE	SPIRITS	Other
Genièvre/Jenever/Gen ever		Netherlan ds/Germa ny/France /Belgium	NL/D E/FR /BE	SPIRITS	Juniper-flavoured spirit drinks
Andruty kaliskie		Poland	PL	FOOD	Class 2.4. Bread, pastry, cakes, confectionery, biscuits and other baker's wares
Bryndza Podhalańska		Poland	PL	FOOD	Class 1.3. Cheeses
Cebularz lubelski		Poland	PL	FOOD	Class 2.4. Bread, pastry, cakes, confectionery, biscuits and other baker's wares
Chleb prądnicki		Poland	PL	FOOD	Class 2.4. Bread, pastry, cakes, confectionery, biscuits and other baker's wares

**Avropa İttifaqı ölkələrinin ərazilərində mühafizə olunan  
coğrafi göstəricilərin siyahısı**

**The list of geographical indications that are protected  
within the territory of the European Union countries**

**Список географических указаний, охраняемых  
на территории стран Европейского Союза**

**Bülleten № 2. 28.02.2019**

Fasola Piękny Jaś z Doliny Dunajca / Fasola z Doliny Dunajca		Poland	PL	FOOD	Class 1.6. Fruit, vegetables and cereals fresh or processed
Fasola Wrzawska		Poland	PL	FOOD	Class 1.6. Fruit, vegetables and cereals fresh or processed
Jabłka grójeckie		Poland	PL	FOOD	Class 1.6. Fruit, vegetables and cereals fresh or processed
Jabłka łąckie		Poland	PL	FOOD	Class 1.6. Fruit, vegetables and cereals fresh or processed
Jagnięcina podhalańska		Poland	PL	FOOD	Class 1.1. Fresh meat (and offal)
Karp zatorski		Poland	PL	FOOD	Class 1.7. Fresh fish, molluscs, and crustaceans and products derived therefrom
Kiełbasa biała parzona wielkopolska		Poland	PL	FOOD	Class 1.2. Meat products (cooked, salted, smoked, etc.)
Kiełbasa lisecka		Poland	PL	FOOD	Class 1.2. Meat products (cooked, salted, smoked, etc.)
Kiełbasa piaszczańska		Poland	PL	FOOD	Class 1.2. Meat products (cooked, salted, smoked, etc.)
Kołocz śląski/kołacz śląski		Poland	PL	FOOD	Class 2.4. Bread, pastry, cakes, confectionery, biscuits and other baker's wares
Krupnioki śląskie		Poland	PL	FOOD	Class 1.2. Meat products (cooked, salted, smoked, etc.)
Miód drahimski		Poland	PL	FOOD	Class 1.4. Other products of animal origin (eggs, honey, various dairy products except butter, etc.)
Miód kurpiowski		Poland	PL	FOOD	Class 1.4. Other products of animal origin (eggs, honey, various dairy products except butter, etc.)
Miód wrzosowy z Borów Dolnośląskich		Poland	PL	FOOD	Class 1.4. Other products of animal origin (eggs, honey, various dairy products except butter, etc.)
Obwarzanek krakowski		Poland	PL	FOOD	Class 2.4. Bread, pastry, cakes, confectionery, biscuits and other baker's wares
Oscypek		Poland	PL	FOOD	Class 1.3. Cheeses
Podkarpacki miód spadziowy		Poland	PL	FOOD	Class 1.4. Other products of animal origin (eggs, honey, various dairy products except butter, etc.)
Redykołka		Poland	PL	FOOD	Class 1.3. Cheeses
Rogal świętomarciński		Poland	PL	FOOD	Class 2.4. Bread, pastry, cakes, confectionery, biscuits and other baker's wares
Ser koryciński swojski		Poland	PL	FOOD	Class 1.3. Cheeses
Śliwka szydłowska		Poland	PL	FOOD	Class 1.6. Fruit, vegetables and cereals fresh or processed

**Avropa İttifaqı ölkələrinin ərazilərində mühafizə olunan  
coğrafi göstəricilərin siyahısı**

**The list of geographical indications that are protected  
within the territory of the European Union countries.**

**Список географических указаний, охраняемых  
на территории стран Европейского Союза**

**Bülleten № 2. 28.02.2019**

Suska sechłońska		Poland	PL	FOOD	Class 1.6. Fruit, vegetables and cereals fresh or processed
Truskawka kaszubska / Kaszëbskô malëna		Poland	PL	FOOD	Class 1.6. Fruit, vegetables and cereals fresh or processed
Wielkopolski ser smażony		Poland	PL	FOOD	Class 1.3. Cheeses
Wiśnia nadwiślanka		Poland	PL	FOOD	Class 1.6. Fruit, vegetables and cereals fresh or processed
Herbal vodka from the North Podlasie Lowland aromatised with an extract of bison grass/Wódka ziołowa z Niziny Północnopodlaskiej aromatyzowana ekstraktem z trawy żubrowej		Poland	PL	SPIRITS	Flavoured vodka
Polish Cherry		Poland	PL	SPIRITS	Liqueur
Polska Wódka/Polish Vodka		Poland	PL	SPIRITS	Vodka
Polska Wódka/Polish Vodka		Poland	PL	SPIRITS	Flavoured vodka
Alheira de Barroso-Montalegre		Portugal	PT	FOOD	Class 1.2. Meat products (cooked, salted, smoked, etc.)
Alheira de Mirandela		Portugal	PT	FOOD	Class 1.2. Meat products (cooked, salted, smoked, etc.)
Alheira de Vinhais		Portugal	PT	FOOD	Class 1.2. Meat products (cooked, salted, smoked, etc.)
Ameixa d'Elvas		Portugal	PT	FOOD	Class 1.6. Fruit, vegetables and cereals fresh or processed
Amêndoa Coberta de Moncorvo		Portugal	PT	FOOD	Class 2.4. Bread, pastry, cakes, confectionery, biscuits and other baker's wares
Amêndoa Douro		Portugal	PT	FOOD	Class 1.6. Fruit, vegetables and cereals fresh or processed
Ananás dos Açores/São Miguel		Portugal	PT	FOOD	Class 1.6. Fruit, vegetables and cereals fresh or processed
Anona da Madeira		Portugal	PT	FOOD	Class 1.6. Fruit, vegetables and cereals fresh or processed
Arroz Carolino das Lezírias Ribatejanas		Portugal	PT	FOOD	Class 1.6. Fruit, vegetables and cereals fresh or processed
Arroz Carolino do Baixo Mondego		Portugal	PT	FOOD	Class 1.6. Fruit, vegetables and cereals fresh or processed
Azeite de Moura		Portugal	PT	FOOD	Class 1.5. Oils and fats (butter, margarine, oil, etc.)
Azeite de Trás-os-Montes		Portugal	PT	FOOD	Class 1.5. Oils and fats (butter, margarine, oil, etc.)
Azeite do Alentejo Interior		Portugal	PT	FOOD	Class 1.5. Oils and fats (butter, margarine, oil, etc.)
Azeites da Beira Interior (Azeite da		Portugal	PT	FOOD	Class 1.5. Oils and fats (butter, margarine, oil, etc.)

**Avropa İttifaqı ölkələrinin ərazilərində mühafizə olunan  
coğrafi göstəricilərin siyahısı**

**The list of geographical indications that are protected  
within the territory of the European Union countries**

**Список географических указаний, охраняемых  
на территории стран Европейского Союза**

**Bülleten № 2. 28.02.2019**

Beira Alta, Azeite da Beira Baixa)					
Azeites do Norte Alentejano		Portugal	PT	FOOD	Class 1.5. Oils and fats (butter, margarine, oil, etc.)
Azeites do Ribatejo		Portugal	PT	FOOD	Class 1.5. Oils and fats (butter, margarine, oil, etc.)
Azeitona de conserva Negrinha de Freixo		Portugal	PT	FOOD	Class 1.6. Fruit, vegetables and cereals fresh or processed
Azeitonas de Conserva de Elvas e Campo Maior		Portugal	PT	FOOD	Class 1.6. Fruit, vegetables and cereals fresh or processed
Batata de Trás-os-Montes		Portugal	PT	FOOD	Class 1.6. Fruit, vegetables and cereals fresh or processed
Batata doce de Aljezur		Portugal	PT	FOOD	Class 1.6. Fruit, vegetables and cereals fresh or processed
Borrego da Beira		Portugal	PT	FOOD	Class 1.1. Fresh meat (and offal)
Borrego de Montemor-o-Novo		Portugal	PT	FOOD	Class 1.1. Fresh meat (and offal)
Borrego do Baixo Alentejo		Portugal	PT	FOOD	Class 1.1. Fresh meat (and offal)
Borrego do Nordeste Alentejano		Portugal	PT	FOOD	Class 1.1. Fresh meat (and offal)
Borrego Serra da Estrela		Portugal	PT	FOOD	Class 1.1. Fresh meat (and offal)
Borrego Terrincho		Portugal	PT	FOOD	Class 1.1. Fresh meat (and offal)
Butelo de Vinhais ; Bucho de Vinhais ; Chouriço de Ossos de Vinhais		Portugal	PT	FOOD	Class 1.2. Meat products (cooked, salted, smoked, etc.)
Cabrito da Beira		Portugal	PT	FOOD	Class 1.1. Fresh meat (and offal)
Cabrito da Gralheira		Portugal	PT	FOOD	Class 1.1. Fresh meat (and offal)
Cabrito das Terras Altas do Minho		Portugal	PT	FOOD	Class 1.1. Fresh meat (and offal)
Cabrito de Barroso		Portugal	PT	FOOD	Class 1.1. Fresh meat (and offal)
Cabrito do Alentejo		Portugal	PT	FOOD	Class 1.1. Fresh meat (and offal)
Cabrito Transmontano		Portugal	PT	FOOD	Class 1.1. Fresh meat (and offal)
Cacholeira Branca de Portalegre		Portugal	PT	FOOD	Class 1.2. Meat products (cooked, salted, smoked, etc.)
Capão de Freamunde		Portugal	PT	FOOD	Class 1.1. Fresh meat (and offal)
Carnalentejana		Portugal	PT	FOOD	Class 1.1. Fresh meat (and offal)
Carne Arouquesa		Portugal	PT	FOOD	Class 1.1. Fresh meat (and offal)
Carne Barrosã		Portugal	PT	FOOD	Class 1.1. Fresh meat (and offal)

**Avropa İttifaqı ölkələrinin ərazilərində mühafizə olunan  
coğrafi göstəricilərin siyahısı**

**The list of geographical indications that are protected  
within the territory of the European Union countries.**

**Список географических указаний, охраняемых  
на территории стран Европейского Союза**

**Bülleten № 2. 28.02.2019**

Carne Cachena da Peneda		Portugal	PT	FOOD	Class 1.1. Fresh meat (and offal)
Carne da Charneca		Portugal	PT	FOOD	Class 1.1. Fresh meat (and offal)
Carne de Bísaro Transmontano ; Carne de Porco Transmontano		Portugal	PT	FOOD	Class 1.1. Fresh meat (and offal)
Carne de Bovino Cruzado dos Lameiros do Barroso		Portugal	PT	FOOD	Class 1.1. Fresh meat (and offal)
Carne de Bravo do Ribatejo		Portugal	PT	FOOD	Class 1.1. Fresh meat (and offal)
Carne de Porco Alentejano		Portugal	PT	FOOD	Class 1.1. Fresh meat (and offal)
Carne dos Açores		Portugal	PT	FOOD	Class 1.1. Fresh meat (and offal)
Carne Marinhova		Portugal	PT	FOOD	Class 1.1. Fresh meat (and offal)
Carne Maronesa		Portugal	PT	FOOD	Class 1.1. Fresh meat (and offal)
Carne Mertolenga		Portugal	PT	FOOD	Class 1.1. Fresh meat (and offal)
Carne Mirandesa		Portugal	PT	FOOD	Class 1.1. Fresh meat (and offal)
Castanha da Padrela		Portugal	PT	FOOD	Class 1.6. Fruit, vegetables and cereals fresh or processed
Castanha da Terra Fria		Portugal	PT	FOOD	Class 1.6. Fruit, vegetables and cereals fresh or processed
Castanha dos Soutos da Lapa		Portugal	PT	FOOD	Class 1.6. Fruit, vegetables and cereals fresh or processed
Castanha Marvão-Portalegre		Portugal	PT	FOOD	Class 1.6. Fruit, vegetables and cereals fresh or processed
Cereja da Cova da Beira		Portugal	PT	FOOD	Class 1.6. Fruit, vegetables and cereals fresh or processed
Cereja de São Julião-Portalegre		Portugal	PT	FOOD	Class 1.6. Fruit, vegetables and cereals fresh or processed
Chouriça de Carne de Barroso-Montalegre		Portugal	PT	FOOD	Class 1.2. Meat products (cooked, salted, smoked, etc.)
Chouriça de Carne de Melgaço		Portugal	PT	FOOD	Class 1.2. Meat products (cooked, salted, smoked, etc.)
Chouriça de Carne de Vinhais ; Linguiça de Vinhais		Portugal	PT	FOOD	Class 1.2. Meat products (cooked, salted, smoked, etc.)
Chouriça de sangue de Melgaço		Portugal	PT	FOOD	Class 1.2. Meat products (cooked, salted, smoked, etc.)
Chouriça Doce de Vinhais		Portugal	PT	FOOD	Class 1.2. Meat products (cooked, salted, smoked, etc.)
Chouriço Azedo de Vinhais ; Azedo de Vinhais ; Chouriço de Pão de Vinhais		Portugal	PT	FOOD	Class 1.2. Meat products (cooked, salted, smoked, etc.)

**Avropa İttifaqı ölkələrinin ərazilərində mühafizə olunan  
coğrafi göstəricilərin siyahısı**

**The list of geographical indications that are protected  
within the territory of the European Union countries**

**Список географических указаний, охраняемых  
на территории стран Европейского Союза**

**Bülleten № 2. 28.02.2019**

Chouriço de Abóbora de Barroso-Montalegre		Portugal	PT	FOOD	Class 1.2. Meat products (cooked, salted, smoked, etc.)
Chouriço de Carne de Estremoz e Borba		Portugal	PT	FOOD	Class 1.2. Meat products (cooked, salted, smoked, etc.)
Chouriço de Portalegre		Portugal	PT	FOOD	Class 1.2. Meat products (cooked, salted, smoked, etc.)
Chouriço grosso de Estremoz e Borba		Portugal	PT	FOOD	Class 1.2. Meat products (cooked, salted, smoked, etc.)
Chouriço Mouro de Portalegre		Portugal	PT	FOOD	Class 1.2. Meat products (cooked, salted, smoked, etc.)
Citrinos do Algarve		Portugal	PT	FOOD	Class 1.6. Fruit, vegetables and cereals fresh or processed
Cordeiro Mirandês / Canhão Mirandês		Portugal	PT	FOOD	Class 1.1. Fresh meat (and offal)
Cordeiro Bragançano		Portugal	PT	FOOD	Class 1.1. Fresh meat (and offal)
Cordeiro de Barroso ; Anho de Barroso ; Cordeiro de leite de Barroso		Portugal	PT	FOOD	Class 1.1. Fresh meat (and offal)
Farinheira de Estremoz e Borba		Portugal	PT	FOOD	Class 1.2. Meat products (cooked, salted, smoked, etc.)
Farinheira de Portalegre		Portugal	PT	FOOD	Class 1.2. Meat products (cooked, salted, smoked, etc.)
Fogaça da Feira		Portugal	PT	FOOD	Class 2.4. Bread, pastry, cakes, confectionery, biscuits and other baker's wares
Folar de Valpaços		Portugal	PT	FOOD	Class 2.4. Bread, pastry, cakes, confectionery, biscuits and other baker's wares
Ginja de Óbidos e Alcobaça		Portugal	PT	FOOD	Class 1.6. Fruit, vegetables and cereals fresh or processed
Linguiça de Portalegre		Portugal	PT	FOOD	Class 1.2. Meat products (cooked, salted, smoked, etc.)
Linguiça do Baixo Alentejo ; Chouriço de carne do Baixo Alentejo		Portugal	PT	FOOD	Class 1.2. Meat products (cooked, salted, smoked, etc.)
Lombo Branco de Portalegre		Portugal	PT	FOOD	Class 1.2. Meat products (cooked, salted, smoked, etc.)
Lombo Enguitado de Portalegre		Portugal	PT	FOOD	Class 1.2. Meat products (cooked, salted, smoked, etc.)
Maçã Bravo de Esmolfe		Portugal	PT	FOOD	Class 1.6. Fruit, vegetables and cereals fresh or processed
Maçã da Beira Alta		Portugal	PT	FOOD	Class 1.6. Fruit, vegetables and cereals fresh or processed
Maçã da Cova da Beira		Portugal	PT	FOOD	Class 1.6. Fruit, vegetables and cereals fresh or processed
Maçã de Alcobaça		Portugal	PT	FOOD	Class 1.6. Fruit, vegetables and cereals fresh or processed
Maçã de Portalegre		Portugal	PT	FOOD	Class 1.6. Fruit, vegetables and cereals fresh or processed



**Avropa İttifaqı ölkələrinin ərazilərində mühafizə olunan  
coğrafi göstəricilərin siyahısı**

**The list of geographical indications that are protected  
within the territory of the European Union countries.**

**Список географических указаний, охраняемых  
на территории стран Европейского Союза**

**Bülleten № 2. 28.02.2019**

Maçã Riscadinha de Palmela		Portugal	PT	FOOD	Class 1.6. Fruit, vegetables and cereals fresh or processed
Maracujá dos Açores/S. Miguel		Portugal	PT	FOOD	Class 1.6. Fruit, vegetables and cereals fresh or processed
Mel da Serra da Lousã		Portugal	PT	FOOD	Class 1.4. Other products of animal origin (eggs, honey, various dairy products except butter, etc.)
Mel da Serra de Monchique		Portugal	PT	FOOD	Class 1.4. Other products of animal origin (eggs, honey, various dairy products except butter, etc.)
Mel da Terra Quente		Portugal	PT	FOOD	Class 1.4. Other products of animal origin (eggs, honey, various dairy products except butter, etc.)
Mel das Terras Altas do Minho		Portugal	PT	FOOD	Class 1.4. Other products of animal origin (eggs, honey, various dairy products except butter, etc.)
Mel de Barroso		Portugal	PT	FOOD	Class 1.4. Other products of animal origin (eggs, honey, various dairy products except butter, etc.)
Mel do Alentejo		Portugal	PT	FOOD	Class 1.4. Other products of animal origin (eggs, honey, various dairy products except butter, etc.)
Mel do Parque de Montezinho		Portugal	PT	FOOD	Class 1.4. Other products of animal origin (eggs, honey, various dairy products except butter, etc.)
Mel do Ribatejo Norte (Serra d'Aire, Albufeira de Castelo de Bode, Bairro, Alto Nabão)		Portugal	PT	FOOD	Class 1.4. Other products of animal origin (eggs, honey, various dairy products except butter, etc.)
Mel dos Açores		Portugal	PT	FOOD	Class 1.4. Other products of animal origin (eggs, honey, various dairy products except butter, etc.)
Meloa de Santa Maria — Açores		Portugal	PT	FOOD	Class 1.6. Fruit, vegetables and cereals fresh or processed
Morcela de Assar de Portalegre		Portugal	PT	FOOD	Class 1.2. Meat products (cooked, salted, smoked, etc.)
Morcela de Cozer de Portalegre		Portugal	PT	FOOD	Class 1.2. Meat products (cooked, salted, smoked, etc.)
Morcela de Estremoz e Borba		Portugal	PT	FOOD	Class 1.2. Meat products (cooked, salted, smoked, etc.)
Ovos Moles de Aveiro		Portugal	PT	FOOD	Class 2.4. Bread, pastry, cakes, confectionery, biscuits and other baker's wares
Paia de Estremoz e Borba		Portugal	PT	FOOD	Class 1.2. Meat products (cooked, salted, smoked, etc.)

**Avropa İttifaqı ölkələrinin ərazilərində mühafizə olunan  
coğrafi göstəricilərin siyahısı**

**The list of geographical indications that are protected  
within the territory of the European Union countries**

**Список географических указаний, охраняемых  
на территории стран Европейского Союза**

**Bülleten № 2. 28.02.2019**

Paia de Lombo de Estremoz e Borba		Portugal	PT	FOOD	Class 1.2. Meat products (cooked, salted, smoked, etc.)
Paia de Toucinho de Estremoz e Borba		Portugal	PT	FOOD	Class 1.2. Meat products (cooked, salted, smoked, etc.)
Painho de Portalegre		Portugal	PT	FOOD	Class 1.2. Meat products (cooked, salted, smoked, etc.)
Paio de Beja		Portugal	PT	FOOD	Class 1.2. Meat products (cooked, salted, smoked, etc.)
Pão de Ló de Ovar		Portugal	PT	FOOD	Class 2.4. Bread, pastry, cakes, confectionery, biscuits and other baker's wares
Pastel de Chaves		Portugal	PT	FOOD	Class 2.4. Bread, pastry, cakes, confectionery, biscuits and other baker's wares
Pastel de Tentúgal		Portugal	PT	FOOD	Class 2.4. Bread, pastry, cakes, confectionery, biscuits and other baker's wares
Pêra Rocha do Oeste		Portugal	PT	FOOD	Class 1.6. Fruit, vegetables and cereals fresh or processed
Pêssego da Cova da Beira		Portugal	PT	FOOD	Class 1.6. Fruit, vegetables and cereals fresh or processed
Presunto de Barrancos /Paleta de Barrancos		Portugal	PT	FOOD	Class 1.2. Meat products (cooked, salted, smoked, etc.)
Presunto de Barroso		Portugal	PT	FOOD	Class 1.2. Meat products (cooked, salted, smoked, etc.)
Presunto de Camp Maior e Elvas ; Paleta de Campo Maior e Elvas		Portugal	PT	FOOD	Class 1.2. Meat products (cooked, salted, smoked, etc.)
Presunto de Melgaço		Portugal	PT	FOOD	Class 1.2. Meat products (cooked, salted, smoked, etc.)
Presunto de Santana da Serra ; Paleta de Santana da Serra		Portugal	PT	FOOD	Class 1.2. Meat products (cooked, salted, smoked, etc.)
Presunto de Vinhais / Presunto Bísaro de Vinhais		Portugal	PT	FOOD	Class 1.2. Meat products (cooked, salted, smoked, etc.)
Presunto do Alentejo ; Paleta do Alentejo		Portugal	PT	FOOD	Class 1.2. Meat products (cooked, salted, smoked, etc.)
Queijo de Azeitão		Portugal	PT	FOOD	Class 1.3. Cheeses
Queijo de Cabra Transmontano/Queijo de Cabra Transmontano Velho		Portugal	PT	FOOD	Class 1.3. Cheeses
Queijo de Évora		Portugal	PT	FOOD	Class 1.3. Cheeses
Queijo de Nisa		Portugal	PT	FOOD	Class 1.3. Cheeses
Queijo do Pico		Portugal	PT	FOOD	Class 1.3. Cheeses
Queijo mestiço de Tolosa		Portugal	PT	FOOD	Class 1.3. Cheeses
Queijo Rabaçal		Portugal	PT	FOOD	Class 1.3. Cheeses
Queijo S. Jorge		Portugal	PT	FOOD	Class 1.3. Cheeses
Queijo Serpa		Portugal	PT	FOOD	Class 1.3. Cheeses

**Avropa İttifaqı ölkələrinin ərazilərində mühafizə olunan  
coğrafi göstəricilərin siyahısı**

**The list of geographical indications that are protected  
within the territory of the European Union countries.**

**Список географических указаний, охраняемых  
на территории стран Европейского Союза**

**Bülleten № 2. 28.02.2019**

Queijo Serra da Estrela		Portugal	PT	FOOD	Class 1.3. Cheeses
Queijo Terrincho		Portugal	PT	FOOD	Class 1.3. Cheeses
Queijos da Beira Baixa (Queijo de Castelo Branco, Queijo Amarelo da Beira Baixa, Queijo Picante da Beira Baixa)		Portugal	PT	FOOD	Class 1.3. Cheeses
Requeijão da Beira Baixa		Portugal	PT	FOOD	Class 1.4. Other products of animal origin (eggs, honey, various dairy products except butter, etc.)
Requeijão Serra da Estrela		Portugal	PT	FOOD	Class 1.4. Other products of animal origin (eggs, honey, various dairy products except butter, etc.)
Sal de Tavira / Flor de Sal de Tavira		Portugal	PT	FOOD	Class 1.8. other products of Annex I of the Treaty (spices etc.)
Salpicão de Barroso-Montalegre		Portugal	PT	FOOD	Class 1.2. Meat products (cooked, salted, smoked, etc.)
Salpicão de Melgaço		Portugal	PT	FOOD	Class 1.2. Meat products (cooked, salted, smoked, etc.)
Salpicão de Vinhais		Portugal	PT	FOOD	Class 1.2. Meat products (cooked, salted, smoked, etc.)
Sanguieira de Barroso-Montalegre		Portugal	PT	FOOD	Class 1.2. Meat products (cooked, salted, smoked, etc.)
Travia da Beira Baixa		Portugal	PT	FOOD	Class 1.4. Other products of animal origin (eggs, honey, various dairy products except butter, etc.)
Vitela de Lafões		Portugal	PT	FOOD	Class 1.1. Fresh meat (and offal)
Aguardente Bagaceira Alentejo		Portugal	PT	SPIRITS	Grape marc spirit or grape marc
Aguardente Bagaceira Bairrada		Portugal	PT	SPIRITS	Grape marc spirit or grape marc
Aguardente Bagaceira da Região dos Vinhos Verdes		Portugal	PT	SPIRITS	Grape marc spirit or grape marc
Aguardente de Vinho Alentejo		Portugal	PT	SPIRITS	Wine spirit
Aguardente de Vinho da Região dos Vinhos Verdes		Portugal	PT	SPIRITS	Wine spirit
Aguardente de Vinho Douro		Portugal	PT	SPIRITS	Wine spirit
Aguardente de Vinho Lourinhã		Portugal	PT	SPIRITS	Wine spirit
Aguardente de Vinho Ribatejo		Portugal	PT	SPIRITS	Wine spirit
Medronho do Algarve		Portugal	PT	SPIRITS	Fruit spirit

**Avropa İttifaqı ölkələrinin ərazilərində mühafizə olunan  
coğrafi göstəricilərin siyahısı**

**The list of geographical indications that are protected  
within the territory of the European Union countries**

**Список географических указаний, охраняемых  
на территории стран Европейского Союза**

**Bülleten № 2. 28.02.2019**

Poncha da Madeira		Portugal	PT	SPIRITS	Liqueur
Rum da Madeira		Portugal	PT	SPIRITS	Rum
Açores		Portugal	PT	WINE	
Alenquer		Portugal	PT	WINE	
Alentejano		Portugal	PT	WINE	
Alentejo		Portugal	PT	WINE	
Algarve		Portugal	PT	WINE	
Arruda		Portugal	PT	WINE	
Bairrada		Portugal	PT	WINE	
Beira Interior		Portugal	PT	WINE	
Biscoitos		Portugal	PT	WINE	
Bucelas		Portugal	PT	WINE	
Carcavelos		Portugal	PT	WINE	
Colares		Portugal	PT	WINE	
Dão		Portugal	PT	WINE	
DoTejo		Portugal	PT	WINE	
Douro		Portugal	PT	WINE	
Duriense		Portugal	PT	WINE	
Encostas d'Aire		Portugal	PT	WINE	
Graciosa		Portugal	PT	WINE	
Lafões		Portugal	PT	WINE	
Lagoa		Portugal	PT	WINE	
Lagos		Portugal	PT	WINE	
Lisboa		Portugal	PT	WINE	
Madeira		Portugal	PT	WINE	
Madeira Wein		Portugal	PT	WINE	
Madeira Wijn		Portugal	PT	WINE	
Madeira Wine		Portugal	PT	WINE	
Madeirense		Portugal	PT	WINE	
Madera		Portugal	PT	WINE	
Madère		Portugal	PT	WINE	
Minho		Portugal	PT	WINE	
Óbidos		Portugal	PT	WINE	
Oporto		Portugal	PT	WINE	
Palmela		Portugal	PT	WINE	
Península de Setúbal		Portugal	PT	WINE	
Pico		Portugal	PT	WINE	
Port		Portugal	PT	WINE	
Port Wine		Portugal	PT	WINE	
Porto		Portugal	PT	WINE	
Portvin		Portugal	PT	WINE	
Portwein		Portugal	PT	WINE	
Portwijn		Portugal	PT	WINE	
Setúbal		Portugal	PT	WINE	
Tavira		Portugal	PT	WINE	
Távora-Varosa		Portugal	PT	WINE	
Tejo		Portugal	PT	WINE	
Terras Madeirenses		Portugal	PT	WINE	
Torres Vedras		Portugal	PT	WINE	
Transmontano		Portugal	PT	WINE	
Trás-os-Montes		Portugal	PT	WINE	
Vin de Madère		Portugal	PT	WINE	

**Avropa İttifaqı ölkələrinin ərazilərində mühafizə olunan  
coğrafi göstəricilərin siyahısı**

**The list of geographical indications that are protected  
within the territory of the European Union countries.**

**Список географических указаний, охраняемых  
на территории стран Европейского Союза**

Bülleten № 2. 28.02.2019

vin de Porto		Portugal	PT	WINE	
Vinho da Madeira		Portugal	PT	WINE	
vinho do Porto		Portugal	PT	WINE	
Vinho Verde		Portugal	PT	WINE	
Vino di Madera		Portugal	PT	WINE	
Maģiun de prune Topoloveni		Romania	RO	FOOD	Class 1.6. Fruit, vegetables and cereals fresh or processed
Novac afumat din Țara Bârsei		Romania	RO	FOOD	Class 1.7. Fresh fish, molluscs, and crustaceans and products derived therefrom
Salam de Sibiu		Romania	RO	FOOD	Class 1.2. Meat products (cooked, salted, smoked, etc.)
Telemea de Ibănești		Romania	RO	FOOD	Class 1.3. Cheeses
Horincă de Cămârzana		Romania	RO	SPIRITS	Fruit spirit
Pălincă		Romania	RO	SPIRITS	Fruit spirit
Țuică de Argeș		Romania	RO	SPIRITS	Fruit spirit
Țuică Zetea de Medieșu Aurit		Romania	RO	SPIRITS	Fruit spirit
Vinars Murfatlar		Romania	RO	SPIRITS	Wine spirit
Vinars Segarcea		Romania	RO	SPIRITS	Wine spirit
Vinars Târnave		Romania	RO	SPIRITS	Wine spirit
Vinars Vaslui		Romania	RO	SPIRITS	Wine spirit
Vinars Vrancea		Romania	RO	SPIRITS	Wine spirit
Aiud		Romania	RO	WINE	
Alba Iulia		Romania	RO	WINE	
Babadag		Romania	RO	WINE	
Banat		Romania	RO	WINE	
Banu Mărăcine		Romania	RO	WINE	
Bohotin		Romania	RO	WINE	
Colinele Dobrogei		Romania	RO	WINE	
Cotești		Romania	RO	WINE	
Cotnari		Romania	RO	WINE	
Crișana		Romania	RO	WINE	
Dealu Bujorului		Romania	RO	WINE	
Dealu Mare		Romania	RO	WINE	
Dealu Mare		Romania	RO	WINE	
Dealu Mare		Romania	RO	WINE	
Dealu Mare		Romania	RO	WINE	
Dealurile Crișanei		Romania	RO	WINE	
Dealurile Moldovei		Romania	RO	WINE	
Dealurile Munteniei		Romania	RO	WINE	
Dealurile Munteniei		Romania	RO	WINE	
Dealurile Olteniei		Romania	RO	WINE	
Dealurile Sătmăruului		Romania	RO	WINE	
Dealurile Transilvaniei		Romania	RO	WINE	
Dealurile Vrancei		Romania	RO	WINE	
Dealurile Zarandului		Romania	RO	WINE	
Drăgășani		Romania	RO	WINE	
Huși		Romania	RO	WINE	
Iana		Romania	RO	WINE	
Iași		Romania	RO	WINE	

**Avropa İttifaqı ölkələrinin ərazilərində mühafizə olunan  
coğrafi göstəricilərin siyahısı**

**The list of geographical indications that are protected  
within the territory of the European Union countries**

**Список географических указаний, охраняемых  
на территории стран Европейского Союза**

**Bülleten № 2. 28.02.2019**

Lechința		Romania	RO	WINE	
Mehedinți		Romania	RO	WINE	
Miniș		Romania	RO	WINE	
Murfatlar		Romania	RO	WINE	
Murfatlar		Romania	RO	WINE	
Nicorești		Romania	RO	WINE	
Odobești		Romania	RO	WINE	
Oltina		Romania	RO	WINE	
Panciu		Romania	RO	WINE	
Panciu		Romania	RO	WINE	
Panciu		Romania	RO	WINE	
Pietroasa		Romania	RO	WINE	
Recaș		Romania	RO	WINE	
Sâmburești		Romania	RO	WINE	
Sarica Niculițel		Romania	RO	WINE	
Sebeș-Apold		Romania	RO	WINE	
Segarcea		Romania	RO	WINE	
Ștefănești		Romania	RO	WINE	
Târnave		Romania	RO	WINE	
Târnave		Romania	RO	WINE	
Teresele Dunării		Romania	RO	WINE	
Viile Carașului		Romania	RO	WINE	
Viile Timișului		Romania	RO	WINE	
Klenovecký syrec		Slovakia	SK	FOOD	Class 1.3. Cheeses
Levický slad		Slovakia	SK	FOOD	Class 1.8. other products of Annex I of the Treaty (spices etc.)
Oravský korbáčik		Slovakia	SK	FOOD	Class 1.3. Cheeses
Paprika Žitava/Žitavská paprika		Slovakia	SK	FOOD	Class 1.8. other products of Annex I of the Treaty (spices etc.)
Skalický trdelník		Slovakia	SK	FOOD	Class 2.4. Bread, pastry, cakes, confectionery, biscuits and other baker's wares
Slovenská bryndza		Slovakia	SK	FOOD	Class 1.3. Cheeses
Slovenská parenica		Slovakia	SK	FOOD	Class 1.3. Cheeses
Slovenský oštiepok		Slovakia	SK	FOOD	Class 1.3. Cheeses
Stupavské zelé		Slovakia	SK	FOOD	Class 1.6. Fruit, vegetables and cereals fresh or processed
Tekovský salámový syr		Slovakia	SK	FOOD	Class 1.3. Cheeses
Zázrivské vojky	Zázrivské vojky	Slovakia	SK	FOOD	Class 1.3. Cheeses
Zázrivský korbáčik		Slovakia	SK	FOOD	Class 1.3. Cheeses
Spišská borovička		Slovakia	SK	SPIRITS	Juniper-flavoured spirit drinks
Južnoslovenská		Slovakia	SK	WINE	
Južnoslovenské		Slovakia	SK	WINE	
Južnoslovenský		Slovakia	SK	WINE	
Karpatská perla		Slovakia	SK	WINE	
Malokarpatská		Slovakia	SK	WINE	
Malokarpatské		Slovakia	SK	WINE	
Malokarpatský		Slovakia	SK	WINE	
Nitrianska		Slovakia	SK	WINE	

**Avropa İttifaqı ölkələrinin ərazilərində mühafizə olunan  
coğrafi göstəricilərin siyahısı**

**The list of geographical indications that are protected  
within the territory of the European Union countries.**

**Список географических указаний, охраняемых  
на территории стран Европейского Союза**

**Bülleten № 2. 28.02.2019**

Nitrianske		Slovakia	SK	WINE	
Nitriansky		Slovakia	SK	WINE	
Skalický rubín		Slovakia	SK	WINE	
Slovenská		Slovakia	SK	WINE	
Slovenské		Slovakia	SK	WINE	
Slovenský		Slovakia	SK	WINE	
Stredoslovenská		Slovakia	SK	WINE	
Stredoslovenské		Slovakia	SK	WINE	
Stredoslovenský		Slovakia	SK	WINE	
Vinohradnícka oblasť Tokaj		Slovakia	SK	WINE	
Východoslovenská		Slovakia	SK	WINE	
Východoslovenské		Slovakia	SK	WINE	
Východoslovenský		Slovakia	SK	WINE	
Bovški sir		Slovenia	SI	FOOD	Class 1.3. Cheeses
Ekstra deviško oljčno olje Slovenske Istre		Slovenia	SI	FOOD	Class 1.5. Oils and fats (butter, margarine, oil, etc.)
Jajca izpod Kamniških planin		Slovenia	SI	FOOD	Class 1.4. Other products of animal origin (eggs, honey, various dairy products except butter, etc.)
Kočevski gozdni med		Slovenia	SI	FOOD	Class 1.4. Other products of animal origin (eggs, honey, various dairy products except butter, etc.)
Kranjska klobasa		Slovenia	SI	FOOD	Class 1.2. Meat products (cooked, salted, smoked, etc.)
Kraška panceta		Slovenia	SI	FOOD	Class 1.2. Meat products (cooked, salted, smoked, etc.)
Kraški med		Slovenia	SI	FOOD	Class 1.4. Other products of animal origin (eggs, honey, various dairy products except butter, etc.)
Kraški pršut		Slovenia	SI	FOOD	Class 1.2. Meat products (cooked, salted, smoked, etc.)
Kraški zašink		Slovenia	SI	FOOD	Class 1.2. Meat products (cooked, salted, smoked, etc.)
Mohant		Slovenia	SI	FOOD	Class 1.3. Cheeses
Nanoški sir		Slovenia	SI	FOOD	Class 1.3. Cheeses
Piranska sol		Slovenia	SI	FOOD	Class 1.8. other products of Annex I of the Treaty (spices etc.)
Prekmurska Šunka		Slovenia	SI	FOOD	Class 1.2. Meat products (cooked, salted, smoked, etc.)
Prleška tünka		Slovenia	SI	FOOD	Class 1.2. Meat products (cooked, salted, smoked, etc.)
Ptujski lük		Slovenia	SI	FOOD	Class 1.6. Fruit, vegetables and cereals fresh or processed
Šebreljski želodec		Slovenia	SI	FOOD	Class 1.2. Meat products (cooked, salted, smoked, etc.)
Slovenski med		Slovenia	SI	FOOD	Class 1.4. Other products of animal origin (eggs, honey,

**Avropa İttifaqı ölkələrinin ərazilərində mühafizə olunan  
coğrafi göstəricilərin siyahısı**

**The list of geographical indications that are protected  
within the territory of the European Union countries**

**Список географических указаний, охраняемых  
на территории стран Европейского Союза**

**Bülleten № 2. 28.02.2019**

					various dairy products except butter, etc.)
Štajerski hmelj		Slovenia	SI	FOOD	Class 1.8. other products of Annex I of the Treaty (spices etc.)
Štajersko prekmursko bučno olje		Slovenia	SI	FOOD	Class 1.5. Oils and fats (butter, margarine, oil, etc.)
Tolminc		Slovenia	SI	FOOD	Class 1.3. Cheeses
Brinjevec		Slovenia	SI	SPIRITS	Fruit spirit
Dolenjski sadjevec		Slovenia	SI	SPIRITS	Fruit spirit
Domači rum		Slovenia	SI	SPIRITS	Other
Janeževc		Slovenia	SI	SPIRITS	Aniseed-flavoured spirit drinks
Orehovec		Slovenia	SI	SPIRITS	Nocino
Pelinkovec		Slovenia	SI	SPIRITS	Liqueur
Slovenska travarica		Slovenia	SI	SPIRITS	Bitter-tasting spirit drinks or bitter
Bela krajina		Slovenia	SI	WINE	
Belokranjec		Slovenia	SI	WINE	
Bizeljčan		Slovenia	SI	WINE	
Bizeljsko Sremič		Slovenia	SI	WINE	
Cviček		Slovenia	SI	WINE	
Dolenjska		Slovenia	SI	WINE	
Goriška Brda		Slovenia	SI	WINE	
Kras		Slovenia	SI	WINE	
Metliška črnina		Slovenia	SI	WINE	
Podravje		Slovenia	SI	WINE	
Posavje		Slovenia	SI	WINE	
Prekmurje		Slovenia	SI	WINE	
Primorska		Slovenia	SI	WINE	
Slovenska Istra		Slovenia	SI	WINE	
Štajerska Slovenija		Slovenia	SI	WINE	
Teran		Slovenia	SI	WINE	
Vipavska dolina		Slovenia	SI	WINE	
Aceite Campo de Calatrava		Spain	ES	FOOD	Class 1.5. Oils and fats (butter, margarine, oil, etc.)
Aceite Campo de Montiel		Spain	ES	FOOD	Class 1.5. Oils and fats (butter, margarine, oil, etc.)
Aceite de La Alcarria		Spain	ES	FOOD	Class 1.5. Oils and fats (butter, margarine, oil, etc.)
Aceite de la Comunitat Valenciana		Spain	ES	FOOD	Class 1.5. Oils and fats (butter, margarine, oil, etc.)
Aceite de la Rioja		Spain	ES	FOOD	Class 1.5. Oils and fats (butter, margarine, oil, etc.)
Aceite de Lucena		Spain	ES	FOOD	Class 1.5. Oils and fats (butter, margarine, oil, etc.)
Aceite de Mallorca ; Aceite mallorquín ; Oli de Mallorca ; Oli mallorquí		Spain	ES	FOOD	Class 1.5. Oils and fats (butter, margarine, oil, etc.)
Aceite de Navarra		Spain	ES	FOOD	Class 1.5. Oils and fats (butter, margarine, oil, etc.)



**Avropa İttifaqı ölkələrinin ərazilərində mühafizə olunan  
coğrafi göstəricilərin siyahısı**

**The list of geographical indications that are protected  
within the territory of the European Union countries.**

**Список географических указаний, охраняемых  
на территории стран Европейского Союза**

**Bülleten № 2. 28.02.2019**

Aceite de Terra Alta ; Oli de Terra Alta		Spain	ES	FOOD	Class 1.5. Oils and fats (butter, margarine, oil, etc.)
Aceite del Baix Ebre- Montsià ; Oli del Baix Ebre-Montsià		Spain	ES	FOOD	Class 1.5. Oils and fats (butter, margarine, oil, etc.)
Aceite del Bajo Aragón		Spain	ES	FOOD	Class 1.5. Oils and fats (butter, margarine, oil, etc.)
Aceite Monterrubio		Spain	ES	FOOD	Class 1.5. Oils and fats (butter, margarine, oil, etc.)
Aceite Sierra del Moncayo		Spain	ES	FOOD	Class 1.5. Oils and fats (butter, margarine, oil, etc.)
Aceituna Aloreña de Málaga		Spain	ES	FOOD	Class 1.6. Fruit, vegetables and cereals fresh or processed
Aceituna de Mallorca / Aceituna Mallorquina / Oliva de Mallorca / Oliva Mallorquina		Spain	ES	FOOD	Class 1.6. Fruit, vegetables and cereals fresh or processed
Afuega'l Pitu		Spain	ES	FOOD	Class 1.3. Cheeses
Ajo Morado de Las Pedroñeras		Spain	ES	FOOD	Class 1.6. Fruit, vegetables and cereals fresh or processed
Alcachofa de Benicarló ; Carxofa de Benicarló		Spain	ES	FOOD	Class 1.6. Fruit, vegetables and cereals fresh or processed
Alcachofa de Tudela		Spain	ES	FOOD	Class 1.6. Fruit, vegetables and cereals fresh or processed
Alfajor de Medina Sidonia		Spain	ES	FOOD	Class 2.4. Bread, pastry, cakes, confectionery, biscuits and other baker's wares
Almendra de Mallorca / Almendra Mallorquina / Ametlla de Mallorca / Ametlla Mallorquina		Spain	ES	FOOD	Class 1.6. Fruit, vegetables and cereals fresh or processed
Alubia de La Bañeza- León		Spain	ES	FOOD	Class 1.6. Fruit, vegetables and cereals fresh or processed
Antequera		Spain	ES	FOOD	Class 1.5. Oils and fats (butter, margarine, oil, etc.)
Arroz de Valencia ; Arròs de València		Spain	ES	FOOD	Class 1.6. Fruit, vegetables and cereals fresh or processed
Arroz del Delta del Ebro / Arròs del Delta de l'Ebre		Spain	ES	FOOD	Class 1.6. Fruit, vegetables and cereals fresh or processed
Arzúa-Ulloa		Spain	ES	FOOD	Class 1.3. Cheeses
Avellana de Reus		Spain	ES	FOOD	Class 1.6. Fruit, vegetables and cereals fresh or processed
Azafrán de la Mancha		Spain	ES	FOOD	Class 1.8. other products of Annex I of the Treaty (spices etc.)
Baena		Spain	ES	FOOD	Class 1.5. Oils and fats (butter, margarine, oil, etc.)
Berenjena de Almagro		Spain	ES	FOOD	Class 1.6. Fruit, vegetables and cereals fresh or processed
Botillo del Bierzo		Spain	ES	FOOD	Class 1.2. Meat products (cooked, salted, smoked, etc.)

**Avropa İttifaqı ölkələrinin ərazilərində mühafizə olunan  
coğrafi göstəricilərin siyahısı**

**The list of geographical indications that are protected  
within the territory of the European Union countries**

**Список географических указаний, охраняемых  
на территории стран Европейского Союза**

**Bülleten № 2. 28.02.2019**

Caballa de Andalucia		Spain	ES	FOOD	Class 1.7. Fresh fish, molluscs, and crustaceans and products derived therefrom
Cabrales		Spain	ES	FOOD	Class 1.3. Cheeses
Calasparra		Spain	ES	FOOD	Class 1.6. Fruit, vegetables and cereals fresh or processed
Calçot de Valls		Spain	ES	FOOD	Class 1.6. Fruit, vegetables and cereals fresh or processed
Capón de Vilalba		Spain	ES	FOOD	Class 1.1. Fresh meat (and offal)
Carne de Ávila		Spain	ES	FOOD	Class 1.1. Fresh meat (and offal)
Carne de Cantabria		Spain	ES	FOOD	Class 1.1. Fresh meat (and offal)
Carne de la Sierra de Guadarrama		Spain	ES	FOOD	Class 1.1. Fresh meat (and offal)
Carne de Salamanca		Spain	ES	FOOD	Class 1.1. Fresh meat (and offal)
Carne de Vacuno del País Vasco/Euskal Okela		Spain	ES	FOOD	Class 1.1. Fresh meat (and offal)
Castaña de Galicia		Spain	ES	FOOD	Class 1.6. Fruit, vegetables and cereals fresh or processed
Cebolla Fuentes de Ebro		Spain	ES	FOOD	Class 1.6. Fruit, vegetables and cereals fresh or processed
Cebreiro		Spain	ES	FOOD	Class 1.3. Cheeses
Cecina de León		Spain	ES	FOOD	Class 1.2. Meat products (cooked, salted, smoked, etc.)
Cereza del Jerte		Spain	ES	FOOD	Class 1.6. Fruit, vegetables and cereals fresh or processed
Cerezas de la Montaña de Alicante		Spain	ES	FOOD	Class 1.6. Fruit, vegetables and cereals fresh or processed
Chirimoya de la Costa tropical de Granada-Málaga		Spain	ES	FOOD	Class 1.6. Fruit, vegetables and cereals fresh or processed
Chorizo de Cantimpalos		Spain	ES	FOOD	Class 1.2. Meat products (cooked, salted, smoked, etc.)
Chorizo Riojano		Spain	ES	FOOD	Class 1.2. Meat products (cooked, salted, smoked, etc.)
Chosco de Tineo		Spain	ES	FOOD	Class 1.2. Meat products (cooked, salted, smoked, etc.)
Chufa de Valencia		Spain	ES	FOOD	Class 1.8. other products of Annex I of the Treaty (spices etc.)
Cítricos Valencianos / Cítrics Valencians		Spain	ES	FOOD	Class 1.6. Fruit, vegetables and cereals fresh or processed
Clementinas de las Tierras del Ebro ; Clementines de les Terres de l'Ebre		Spain	ES	FOOD	Class 1.6. Fruit, vegetables and cereals fresh or processed
Cochinilla de Canarias		Spain	ES	FOOD	Class 3.4. Cochineal (raw product of animal origin)

**Avropa İttifaqı ölkələrinin ərazilərində mühafizə olunan  
coğrafi göstəricilərin siyahısı**

**The list of geographical indications that are protected  
within the territory of the European Union countries.**

**Список географических указаний, охраняемых  
на территории стран Европейского Союза**

**Bülleten № 2. 28.02.2019**

Coliflor de Calahorra		Spain	ES	FOOD	Class 1.6. Fruit, vegetables and cereals fresh or processed
Cordero de Extremadura		Spain	ES	FOOD	Class 1.1. Fresh meat (and offal)
Cordero de Navarra ; Nafarroako Arkumea		Spain	ES	FOOD	Class 1.1. Fresh meat (and offal)
Cordero Manchego		Spain	ES	FOOD	Class 1.1. Fresh meat (and offal)
Cordero Segureño		Spain	ES	FOOD	Class 1.1. Fresh meat (and offal)
Dehesa de Extremadura		Spain	ES	FOOD	Class 1.2. Meat products (cooked, salted, smoked, etc.)
Ensaimada de Mallorca ; Ensaimada mallorquina		Spain	ES	FOOD	Class 2.4. Bread, pastry, cakes, confectionery, biscuits and other baker's wares
Espárrago de Huétor-Tájar		Spain	ES	FOOD	Class 1.6. Fruit, vegetables and cereals fresh or processed
Espárrago de Navarra		Spain	ES	FOOD	Class 1.6. Fruit, vegetables and cereals fresh or processed
Estepa		Spain	ES	FOOD	Class 1.5. Oils and fats (butter, margarine, oil, etc.)
Faba Asturiana		Spain	ES	FOOD	Class 1.6. Fruit, vegetables and cereals fresh or processed
Faba de Lourenzá		Spain	ES	FOOD	Class 1.6. Fruit, vegetables and cereals fresh or processed
Fesols de Santa Pau		Spain	ES	FOOD	Class 1.6. Fruit, vegetables and cereals fresh or processed
Gall del Penedès		Spain	ES	FOOD	Class 1.1. Fresh meat (and offal)
Gamoneu ; Gamonedo		Spain	ES	FOOD	Class 1.3. Cheeses
Garbanzo de Escacena		Spain	ES	FOOD	Class 1.6. Fruit, vegetables and cereals fresh or processed
Garbanzo de Fuentesauco		Spain	ES	FOOD	Class 1.6. Fruit, vegetables and cereals fresh or processed
Gata-Hurdes		Spain	ES	FOOD	Class 1.5. Oils and fats (butter, margarine, oil, etc.)
Gofio Canario		Spain	ES	FOOD	Class 1.6. Fruit, vegetables and cereals fresh or processed
Granada Mollar de Elche/Granada de Elche		Spain	ES	FOOD	Class 1.6. Fruit, vegetables and cereals fresh or processed
Grellos de Galicia		Spain	ES	FOOD	Class 1.6. Fruit, vegetables and cereals fresh or processed
Guijuelo		Spain	ES	FOOD	Class 1.2. Meat products (cooked, salted, smoked, etc.)
Idiazabal		Spain	ES	FOOD	Class 1.3. Cheeses
Jabugo		Spain	ES	FOOD	Class 1.2. Meat products (cooked, salted, smoked, etc.)
Jamón de Serón		Spain	ES	FOOD	Class 1.2. Meat products (cooked, salted, smoked, etc.)
Jamón de Teruel/Paleta de Teruel		Spain	ES	FOOD	Class 1.2. Meat products (cooked, salted, smoked, etc.)

**Avropa İttifaqı ölkələrinin ərazilərində mühafizə olunan  
coğrafi göstəricilərin siyahısı**

**The list of geographical indications that are protected  
within the territory of the European Union countries**

**Список географических указаний, охраняемых  
на территории стран Европейского Союза**

**Bülleten № 2. 28.02.2019**

Jamón de Trevélez		Spain	ES	FOOD	Class 1.2. Meat products (cooked, salted, smoked, etc.)
Jijona		Spain	ES	FOOD	Class 2.4. Bread, pastry, cakes, confectionery, biscuits and other baker's wares
Judías de El Barco de Ávila		Spain	ES	FOOD	Class 1.6. Fruit, vegetables and cereals fresh or processed
Kaki Ribera del Xúquer		Spain	ES	FOOD	Class 1.6. Fruit, vegetables and cereals fresh or processed
Lacón Gallego		Spain	ES	FOOD	Class 1.2. Meat products (cooked, salted, smoked, etc.)
Lechazo de Castilla y León		Spain	ES	FOOD	Class 1.1. Fresh meat (and offal)
Lenteja de La Armuña		Spain	ES	FOOD	Class 1.6. Fruit, vegetables and cereals fresh or processed
Lenteja de Tierra de Campos		Spain	ES	FOOD	Class 1.6. Fruit, vegetables and cereals fresh or processed
Les Garrigues		Spain	ES	FOOD	Class 1.5. Oils and fats (butter, margarine, oil, etc.)
Los Pedroches		Spain	ES	FOOD	Class 1.2. Meat products (cooked, salted, smoked, etc.)
Mahón-Menorca		Spain	ES	FOOD	Class 1.3. Cheeses
Mantecadas de Astorga		Spain	ES	FOOD	Class 2.4. Bread, pastry, cakes, confectionery, biscuits and other baker's wares
Mantecados de Estepa		Spain	ES	FOOD	Class 2.4. Bread, pastry, cakes, confectionery, biscuits and other baker's wares
Mantequilla de l'Alt Urgell y la Cerdanya ; Mantega de l'Alt Urgell i la Cerdanya		Spain	ES	FOOD	Class 1.5. Oils and fats (butter, margarine, oil, etc.)
Mantequilla de Soria		Spain	ES	FOOD	Class 1.5. Oils and fats (butter, margarine, oil, etc.)
Manzana de Girona ; Poma de Girona		Spain	ES	FOOD	Class 1.6. Fruit, vegetables and cereals fresh or processed
Manzana Reineta del Bierzo		Spain	ES	FOOD	Class 1.6. Fruit, vegetables and cereals fresh or processed
Mejillón de Galicia ; Mexillón de Galicia		Spain	ES	FOOD	Class 1.7. Fresh fish, molluscs, and crustaceans and products derived therefrom
Melocotón de Calanda		Spain	ES	FOOD	Class 1.6. Fruit, vegetables and cereals fresh or processed
Melón de la Mancha		Spain	ES	FOOD	Class 1.6. Fruit, vegetables and cereals fresh or processed
Melón de Torre Pacheco-Murcia		Spain	ES	FOOD	Class 1.6. Fruit, vegetables and cereals fresh or processed
Melva de Andalucía		Spain	ES	FOOD	Class 1.7. Fresh fish, molluscs, and crustaceans and products derived therefrom
Miel de Galicia ; Mel de Galicia		Spain	ES	FOOD	Class 1.4. Other products of animal origin (eggs, honey,

**Avropa İttifaqı ölkələrinin ərazilərində mühafizə olunan  
coğrafi göstəricilərin siyahısı**

**The list of geographical indications that are protected  
within the territory of the European Union countries.**

**Список географических указаний, охраняемых  
на территории стран Европейского Союза**

**Bülleten № 2. 28.02.2019**

					various dairy products except butter, etc.)
Miel de Granada		Spain	ES	FOOD	Class 1.4. Other products of animal origin (eggs, honey, various dairy products except butter, etc.)
Miel de La Alcarria		Spain	ES	FOOD	Class 1.4. Other products of animal origin (eggs, honey, various dairy products except butter, etc.)
Miel de Liébana		Spain	ES	FOOD	Class 1.4. Other products of animal origin (eggs, honey, various dairy products except butter, etc.)
Miel de Tenerife		Spain	ES	FOOD	Class 1.4. Other products of animal origin (eggs, honey, various dairy products except butter, etc.)
Miel Villuercas-Ibores		Spain	ES	FOOD	Class 1.4. Other products of animal origin (eggs, honey, various dairy products except butter, etc.)
Mojama de Barbate		Spain	ES	FOOD	Class 1.7. Fresh fish, molluscs, and crustaceans and products derived therefrom
Mojama de Isla Cristina		Spain	ES	FOOD	Class 1.7. Fresh fish, molluscs, and crustaceans and products derived therefrom
Mongeta del Ganxet		Spain	ES	FOOD	Class 1.6. Fruit, vegetables and cereals fresh or processed
Montes de Granada		Spain	ES	FOOD	Class 1.5. Oils and fats (butter, margarine, oil, etc.)
Montes de Toledo		Spain	ES	FOOD	Class 1.5. Oils and fats (butter, margarine, oil, etc.)
Montoro-Adamuz		Spain	ES	FOOD	Class 1.5. Oils and fats (butter, margarine, oil, etc.)
Nísperos Callosa d'En Sarriá		Spain	ES	FOOD	Class 1.6. Fruit, vegetables and cereals fresh or processed
Oli de l'Empordà/Aceite de L'Empordà		Spain	ES	FOOD	Class 1.5. Oils and fats (butter, margarine, oil, etc.)
Pa de Pagès Català		Spain	ES	FOOD	Class 2.4. Bread, pastry, cakes, confectionery, biscuits and other baker's wares
Pan de Alfacar		Spain	ES	FOOD	Class 2.4. Bread, pastry, cakes, confectionery, biscuits and other baker's wares
Pan de Cea		Spain	ES	FOOD	Class 2.4. Bread, pastry, cakes, confectionery, biscuits and other baker's wares
Pan de Cruz de Ciudad Real		Spain	ES	FOOD	Class 2.4. Bread, pastry, cakes, confectionery, biscuits and other baker's wares

**Avropa İttifaqı ölkələrinin ərazilərində mühafizə olunan  
coğrafi göstəricilərin siyahısı**

**The list of geographical indications that are protected  
within the territory of the European Union countries**

**Список географических указаний, охраняемых  
на территории стран Европейского Союза**

**Bülleten № 2. 28.02.2019**

Papas Antiguas de Canarias		Spain	ES	FOOD	Class 1.6. Fruit, vegetables and cereals fresh or processed
Pasas de Málaga		Spain	ES	FOOD	Class 1.6. Fruit, vegetables and cereals fresh or processed
Pataca de Galicia / Patata de Galicia		Spain	ES	FOOD	Class 1.6. Fruit, vegetables and cereals fresh or processed
Patatas de Prades ; Patates de Prades		Spain	ES	FOOD	Class 1.6. Fruit, vegetables and cereals fresh or processed
Pemento da Arnoia		Spain	ES	FOOD	Class 1.6. Fruit, vegetables and cereals fresh or processed
Pemento de Herbón		Spain	ES	FOOD	Class 1.6. Fruit, vegetables and cereals fresh or processed
Pemento de Mougán		Spain	ES	FOOD	Class 1.6. Fruit, vegetables and cereals fresh or processed
Pemento de Oímbra		Spain	ES	FOOD	Class 1.6. Fruit, vegetables and cereals fresh or processed
Pemento do Couto		Spain	ES	FOOD	Class 1.6. Fruit, vegetables and cereals fresh or processed
Pera de Jumilla		Spain	ES	FOOD	Class 1.6. Fruit, vegetables and cereals fresh or processed
Pera de Lleida		Spain	ES	FOOD	Class 1.6. Fruit, vegetables and cereals fresh or processed
Peras de Rincón de Soto		Spain	ES	FOOD	Class 1.6. Fruit, vegetables and cereals fresh or processed
Picón Bejes-Tresviso		Spain	ES	FOOD	Class 1.3. Cheeses
Pimentón de la Vera		Spain	ES	FOOD	Class 1.8. other products of Annex I of the Treaty (spices etc.)
Pimentón de Murcia		Spain	ES	FOOD	Class 1.8. other products of Annex I of the Treaty (spices etc.)
Pimiento Asado del Bierzo		Spain	ES	FOOD	Class 1.6. Fruit, vegetables and cereals fresh or processed
Pimiento de Fresno-Benavente		Spain	ES	FOOD	Class 1.6. Fruit, vegetables and cereals fresh or processed
Pimiento de Gernika or Gernikako Piperra		Spain	ES	FOOD	Class 1.6. Fruit, vegetables and cereals fresh or processed
Pimiento Riojano		Spain	ES	FOOD	Class 1.6. Fruit, vegetables and cereals fresh or processed
Pimientos del Piquillo de Lodosa		Spain	ES	FOOD	Class 1.6. Fruit, vegetables and cereals fresh or processed
Plátano de Canarias		Spain	ES	FOOD	Class 1.6. Fruit, vegetables and cereals fresh or processed
Pollo y Capón del Prat		Spain	ES	FOOD	Class 1.1. Fresh meat (and offal)
Polvorones de Estepa		Spain	ES	FOOD	Class 2.4. Bread, pastry, cakes, confectionery, biscuits and other baker's wares
Poniente de Granada		Spain	ES	FOOD	Class 1.5. Oils and fats (butter, margarine, oil, etc.)
Priego de Córdoba		Spain	ES	FOOD	Class 1.5. Oils and fats (butter, margarine, oil, etc.)
Queso Camerano		Spain	ES	FOOD	Class 1.3. Cheeses

**Avropa İttifaqı ölkələrinin ərazilərində mühafizə olunan  
coğrafi göstəricilərin siyahısı**

**The list of geographical indications that are protected  
within the territory of the European Union countries.**

**Список географических указаний, охраняемых  
на территории стран Европейского Союза**

**Bülleten № 2. 28.02.2019**

Queso Casin		Spain	ES	FOOD	Class 1.3. Cheeses
Queso de Flor de Guía / Queso de Media Flor de Guía / Queso de Guía		Spain	ES	FOOD	Class 1.3. Cheeses
Queso de La Serena		Spain	ES	FOOD	Class 1.3. Cheeses
Queso de l'Alt Urgell y la Cerdanya		Spain	ES	FOOD	Class 1.3. Cheeses
Queso de Murcia		Spain	ES	FOOD	Class 1.3. Cheeses
Queso de Murcia al vino		Spain	ES	FOOD	Class 1.3. Cheeses
Queso de Valdeón		Spain	ES	FOOD	Class 1.3. Cheeses
Queso Ibores		Spain	ES	FOOD	Class 1.3. Cheeses
Queso Los Beyos		Spain	ES	FOOD	Class 1.3. Cheeses
Queso Majorero		Spain	ES	FOOD	Class 1.3. Cheeses
Queso Manchego		Spain	ES	FOOD	Class 1.3. Cheeses
Queso Nata de Cantabria		Spain	ES	FOOD	Class 1.3. Cheeses
Queso Palmero ; Queso de la Palma		Spain	ES	FOOD	Class 1.3. Cheeses
Queso Tetilla / Queixo Tetilla		Spain	ES	FOOD	Class 1.3. Cheeses
Queso Zamorano		Spain	ES	FOOD	Class 1.3. Cheeses
Quesucos de Liébana		Spain	ES	FOOD	Class 1.3. Cheeses
Roncal		Spain	ES	FOOD	Class 1.3. Cheeses
Salchichón de Vic/Llonganissa de Vic		Spain	ES	FOOD	Class 1.2. Meat products (cooked, salted, smoked, etc.)
San Simón da Costa		Spain	ES	FOOD	Class 1.3. Cheeses
Sidra de Asturias ; Sidra d'Asturies		Spain	ES	FOOD	Class 1.8. other products of Annex I of the Treaty (spices etc.)
Sierra de Cádiz		Spain	ES	FOOD	Class 1.5. Oils and fats (butter, margarine, oil, etc.)
Sierra de Cazorla		Spain	ES	FOOD	Class 1.5. Oils and fats (butter, margarine, oil, etc.)
Sierra de Segura		Spain	ES	FOOD	Class 1.5. Oils and fats (butter, margarine, oil, etc.)
Sierra Mágina		Spain	ES	FOOD	Class 1.5. Oils and fats (butter, margarine, oil, etc.)
Siurana		Spain	ES	FOOD	Class 1.5. Oils and fats (butter, margarine, oil, etc.)
Sobao Pasiego		Spain	ES	FOOD	Class 2.4. Bread, pastry, cakes, confectionery, biscuits and other baker's wares
Sobrasada de Mallorca		Spain	ES	FOOD	Class 1.2. Meat products (cooked, salted, smoked, etc.)
Tarta de Santiago		Spain	ES	FOOD	Class 2.4. Bread, pastry, cakes, confectionery, biscuits and other baker's wares
Ternasco de Aragón		Spain	ES	FOOD	Class 1.1. Fresh meat (and offal)
Ternera Asturiana		Spain	ES	FOOD	Class 1.1. Fresh meat (and offal)

**Avropa İttifaqı ölkələrinin ərazilərində mühafizə olunan  
coğrafi göstəricilərin siyahısı**

**The list of geographical indications that are protected  
within the territory of the European Union countries**

**Список географических указаний, охраняемых  
на территории стран Европейского Союза**

**Bülleten № 2. 28.02.2019**

Tenera de Aliste		Spain	ES	FOOD	Class 1.1. Fresh meat (and offal)
Tenera de Extremadura		Spain	ES	FOOD	Class 1.1. Fresh meat (and offal)
Tenera de Navarra ; Nafarroako Aratxea		Spain	ES	FOOD	Class 1.1. Fresh meat (and offal)
Tenera Gallega		Spain	ES	FOOD	Class 1.1. Fresh meat (and offal)
Tomate La Cañada		Spain	ES	FOOD	Class 1.6. Fruit, vegetables and cereals fresh or processed
Torta del Casar		Spain	ES	FOOD	Class 1.3. Cheeses
Turrón de Agramunt ; Torró d'Agramunt		Spain	ES	FOOD	Class 2.4. Bread, pastry, cakes, confectionery, biscuits and other baker's wares
Turrón de Alicante		Spain	ES	FOOD	Class 2.4. Bread, pastry, cakes, confectionery, biscuits and other baker's wares
Uva de mesa embolsada "Vinalopó"		Spain	ES	FOOD	Class 1.6. Fruit, vegetables and cereals fresh or processed
Vinagre de Jerez		Spain	ES	FOOD	Class 1.8. other products of Annex I of the Treaty (spices etc.)
Vinagre de Montilla-Moriles		Spain	ES	FOOD	Class 1.8. other products of Annex I of the Treaty (spices etc.)
Vinagre del Condado de Huelva		Spain	ES	FOOD	Class 1.8. other products of Annex I of the Treaty (spices etc.)
Aguardiente de hierbas de Galicia		Spain	ES	SPIRITS	Other
Aguardiente de sidra de Asturias		Spain	ES	SPIRITS	Cider spirit and perry spirit
Anís Paloma Monforte del Cid		Spain	ES	SPIRITS	Aniseed-flavoured spirit drinks
Aperitivo Café de Alcoy		Spain	ES	SPIRITS	Other
Brandy de Jerez		Spain	ES	SPIRITS	Brandy or Weinbrand
Brandy del Penedés		Spain	ES	SPIRITS	Brandy or Weinbrand
Cantueso Alicantino		Spain	ES	SPIRITS	Liqueur
Chinchón		Spain	ES	SPIRITS	Aniseed-flavoured spirit drinks
Gin de Mahón		Spain	ES	SPIRITS	Juniper-flavoured spirit drinks
Herbero de la Sierra de Mariola		Spain	ES	SPIRITS	Other
Hierbas de Mallorca		Spain	ES	SPIRITS	Aniseed-flavoured spirit drinks
Hierbas Ibicencas		Spain	ES	SPIRITS	Aniseed-flavoured spirit drinks
Licor café de Galicia		Spain	ES	SPIRITS	Liqueur
Licor de hierbas de Galicia		Spain	ES	SPIRITS	Liqueur
Orujo de Galicia		Spain	ES	SPIRITS	Grape marc spirit or grape marc



**Avropa İttifaqı ölkələrinin ərazilərində mühafizə olunan  
coğrafi göstəricilərin siyahısı**

**The list of geographical indications that are protected  
within the territory of the European Union countries.**

**Список географических указаний, охраняемых  
на территории стран Европейского Союза**

Bülleten № 2. 28.02.2019

Pacharán navarro		Spain	ES	SPIRITS	Other
Palo de Mallorca		Spain	ES	SPIRITS	Liqueur
Ratafia catalana		Spain	ES	SPIRITS	Liqueur
Ronmiel de Canarias		Spain	ES	SPIRITS	Other
3 Riberas		Spain	ES	WINE	
Abona		Spain	ES	WINE	
Alella		Spain	ES	WINE	
Alicante		Spain	ES	WINE	
Almansa		Spain	ES	WINE	
Altiplano de Sierra Nevada		Spain	ES	WINE	
Arabako Txakolina		Spain	ES	WINE	
Arlanza		Spain	ES	WINE	
Arribes		Spain	ES	WINE	
Aylés		Spain	ES	WINE	
Bailén		Spain	ES	WINE	
Bajo Aragón		Spain	ES	WINE	
Barbanza e Iria		Spain	ES	WINE	
Betanzos		Spain	ES	WINE	
Bierzo		Spain	ES	WINE	
Binissalem		Spain	ES	WINE	
Bizkaiko Txakolina		Spain	ES	WINE	
Bullas		Spain	ES	WINE	
Cádiz		Spain	ES	WINE	
Calatayud		Spain	ES	WINE	
Calzadilla		Spain	ES	WINE	
Campo de Borja		Spain	ES	WINE	
Campo de Cartagena		Spain	ES	WINE	
Campo de La Guardia		Spain	ES	WINE	
Cangas		Spain	ES	WINE	
Cariñena		Spain	ES	WINE	
Casa del Blanco		Spain	ES	WINE	
Castelló		Spain	ES	WINE	
Castilla		Spain	ES	WINE	
Castilla y León		Spain	ES	WINE	
Cataluña		Spain	ES	WINE	
Catalunya		Spain	ES	WINE	
Cava		Spain	ES	WINE	
Chacolí de Álava		Spain	ES	WINE	
Chacolí de Bizkaia		Spain	ES	WINE	
Chacolí de Getaria		Spain	ES	WINE	
Cigales		Spain	ES	WINE	
Conca de Barberà		Spain	ES	WINE	
Condado de Huelva		Spain	ES	WINE	
Córdoba		Spain	ES	WINE	
Costa de Cantabria		Spain	ES	WINE	
Costers del Segre		Spain	ES	WINE	
Cumbres del Guadalfeo		Spain	ES	WINE	
Dehesa del Carrizal		Spain	ES	WINE	
Desierto de Almería		Spain	ES	WINE	
Dominio de Valdepusa		Spain	ES	WINE	

**Avropa İttifaqı ölkələrinin ərazilərində mühafizə olunan  
coğrafi göstəricilərin siyahısı**

**The list of geographical indications that are protected  
within the territory of the European Union countries**

**Список географических указаний, охраняемых  
на территории стран Европейского Союза**

**Bülleten № 2. 28.02.2019**

Eivissa		Spain	ES	WINE	
El Hierro		Spain	ES	WINE	
El Terrerazo		Spain	ES	WINE	
Empordà		Spain	ES	WINE	
Extremadura		Spain	ES	WINE	
Finca Élez		Spain	ES	WINE	
Formentera		Spain	ES	WINE	
Getariako Txakolina		Spain	ES	WINE	
Gran Canaria		Spain	ES	WINE	
Granada		Spain	ES	WINE	
Guijoso		Spain	ES	WINE	
Ibiza		Spain	ES	WINE	
Illa de Menorca		Spain	ES	WINE	
Illes Balears		Spain	ES	WINE	
Isla de Menorca		Spain	ES	WINE	
Islas Canarias		Spain	ES	WINE	
Jerez		Spain	ES	WINE	
Jerez-Xérès-Sherry		Spain	ES	WINE	
Jumilla		Spain	ES	WINE	
La Gomera		Spain	ES	WINE	
La Mancha		Spain	ES	WINE	
La Palma		Spain	ES	WINE	
Laderas del Genil		Spain	ES	WINE	
Lanzarote		Spain	ES	WINE	
Laujar-Alpujarra		Spain	ES	WINE	
Lebrija		Spain	ES	WINE	
Liébana		Spain	ES	WINE	
Los Balagueses		Spain	ES	WINE	
Los Palacios		Spain	ES	WINE	
Málaga		Spain	ES	WINE	
Mallorca		Spain	ES	WINE	
Manchuela		Spain	ES	WINE	
Manzanilla		Spain	ES	WINE	
Manzanilla-Sanlúcar de Barrameda		Spain	ES	WINE	
Méntrida		Spain	ES	WINE	
Mondéjar		Spain	ES	WINE	
Monterrei		Spain	ES	WINE	
Montilla-Moriles		Spain	ES	WINE	
Montsant		Spain	ES	WINE	
Murcia		Spain	ES	WINE	
Navarra		Spain	ES	WINE	
Norte de Almería		Spain	ES	WINE	
Pago de Arínzano		Spain	ES	WINE	
Pago de Otazu		Spain	ES	WINE	
Pago Florentino		Spain	ES	WINE	
Penedès		Spain	ES	WINE	
Pla de Bages		Spain	ES	WINE	
Pla i Llevant		Spain	ES	WINE	
Prado de Irache		Spain	ES	WINE	
Priorat		Spain	ES	WINE	
Priorato		Spain	ES	WINE	

**Avropa İttifaqı ölkələrinin ərazilərində mühafizə olunan  
coğrafi göstəricilərin siyahısı**

**The list of geographical indications that are protected  
within the territory of the European Union countries.**

**Список географических указаний, охраняемых  
на территории стран Европейского Союза**

Bülleten № 2. 28.02.2019

Rías Baixas		Spain	ES	WINE	
Ribeira Sacra		Spain	ES	WINE	
Ribeiras do Morrazo		Spain	ES	WINE	
Ribeiro		Spain	ES	WINE	
Ribera del Andarax		Spain	ES	WINE	
Ribera del Duero		Spain	ES	WINE	
Ribera del Gállego - Cinco Villas		Spain	ES	WINE	
Ribera del Guadiana		Spain	ES	WINE	
Ribera del Jiloca		Spain	ES	WINE	
Ribera del Júcar		Spain	ES	WINE	
Ribera del Queiles		Spain	ES	WINE	
Rioja		Spain	ES	WINE	
Rueda		Spain	ES	WINE	
Serra de Tramuntana- Costa Nord		Spain	ES	WINE	
Sherry		Spain	ES	WINE	
Sierra de Salamanca		Spain	ES	WINE	
Sierra Norte de Sevilla		Spain	ES	WINE	
Sierra Sur de Jaén		Spain	ES	WINE	
Sierras de Las Estancias y Los Filabres		Spain	ES	WINE	
Sierras de Málaga		Spain	ES	WINE	
Somontano		Spain	ES	WINE	
Tacoronte-Acentejo		Spain	ES	WINE	
Tarragona		Spain	ES	WINE	
Terra Alta		Spain	ES	WINE	
Tierra de León		Spain	ES	WINE	
Tierra del Vino de Zamora		Spain	ES	WINE	
Toro		Spain	ES	WINE	
Torreperogil		Spain	ES	WINE	
Txakolí de Álava		Spain	ES	WINE	
Txakolí de Bizkaia		Spain	ES	WINE	
Txakolí de Getaria		Spain	ES	WINE	
Uclés		Spain	ES	WINE	
Utiel-Requena		Spain	ES	WINE	
Val do Miño-Ourense		Spain	ES	WINE	
Valdejalón		Spain	ES	WINE	
Valdeorras		Spain	ES	WINE	
Valdepeñas		Spain	ES	WINE	
Valencia		Spain	ES	WINE	
Valle de Güímar		Spain	ES	WINE	
Valle de la Orotava		Spain	ES	WINE	
Valle del Cinca		Spain	ES	WINE	
Valle del Miño- Ourense		Spain	ES	WINE	
Valles de Benavente		Spain	ES	WINE	
Valles de Sadacia		Spain	ES	WINE	
Valtiendas		Spain	ES	WINE	

**Avropa İttifaqı ölkələrinin ərazilərində mühafizə olunan  
coğrafi göstəricilərin siyahısı**

**The list of geographical indications that are protected  
within the territory of the European Union countries**

**Список географических указаний, охраняемых  
на территории стран Европейского Союза**

**Bülleten № 2. 28.02.2019**

Villaviciosa de Córdoba		Spain	ES	WINE	
Vinos de Madrid		Spain	ES	WINE	
Xérès		Spain	ES	WINE	
Ycoden-Isora		Spain	ES	WINE	
Yecla		Spain	ES	WINE	
Tenera de los Pirineos Catalanes / Vedella dels Pirineus Catalans / Vedell des Pyrénées Catalanes		Spain/France	ES/FR	FOOD	Class 1.1. Fresh meat (and offal)
Bruna bönor från Öland		Sweden	SE	FOOD	Class 1.6. Fruit, vegetables and cereals fresh or processed
Hännlamb		Sweden	SE	FOOD	Class 1.1. Fresh meat (and offal)
Kalix Löjrom		Sweden	SE	FOOD	Class 1.7. Fresh fish, molluscs, and crustaceans and products derived therefrom
Skånsk spettekaka		Sweden	SE	FOOD	Class 2.4. Bread, pastry, cakes, confectionery, biscuits and other baker's wares
Svecia		Sweden	SE	FOOD	Class 1.3. Cheeses
Upplandskubb		Sweden	SE	FOOD	Class 2.4. Bread, pastry, cakes, confectionery, biscuits and other baker's wares
Svensk Aquavit/Svensk Akvavit/Swedish Aquavit		Sweden	SE	SPIRITS	Akvavit or aquavit
Svensk Punsch/Swedish Punch		Sweden	SE	SPIRITS	Other
Svensk Vodka/Swedish Vodka		Sweden	SE	SPIRITS	Vodka
Anglesey Sea Salt / Halen Môn		United Kingdom	GB	FOOD	Class 1.8. other products of Annex I of the Treaty (spices etc.)
Arbroath Smokies		United Kingdom	GB	FOOD	Class 1.7. Fresh fish, molluscs, and crustaceans and products derived therefrom
Armagh Bramley Apples		United Kingdom	GB	FOOD	Class 1.6. Fruit, vegetables and cereals fresh or processed
Beacon Fell traditional Lancashire cheese		United Kingdom	GB	FOOD	Class 1.3. Cheeses
Bonchester cheese		United Kingdom	GB	FOOD	Class 1.3. Cheeses
Buxton blue		United Kingdom	GB	FOOD	Class 1.3. Cheeses
Carmarthen Ham		United Kingdom	GB	FOOD	Class 1.2. Meat products (cooked, salted, smoked, etc.)
Conwy Mussels		United Kingdom	GB	FOOD	Class 1.7. Fresh fish, molluscs, and crustaceans and products derived therefrom
Cornish Clotted Cream		United Kingdom	GB	FOOD	Class 1.4. Other products of animal origin (eggs, honey, various dairy products except butter, etc.)
Cornish Pasty		United Kingdom	GB	FOOD	Class 2.4. Bread, pastry, cakes, confectionery, biscuits and other baker's wares

**Avropa İttifaqı ölkələrinin ərazilərində mühafizə olunan  
coğrafi göstəricilərin siyahısı**

**The list of geographical indications that are protected  
within the territory of the European Union countries.**

**Список географических указаний, охраняемых  
на территории стран Европейского Союза**

**Bülleten № 2. 28.02.2019**

Cornish Sardines		United Kingdom	GB	FOOD	Class 1.7. Fresh fish, molluscs, and crustaceans and products derived therefrom
Dorset Blue Cheese		United Kingdom	GB	FOOD	Class 1.3. Cheeses
Dovedale cheese		United Kingdom	GB	FOOD	Class 1.3. Cheeses
East Kent Goldings		United Kingdom	GB	FOOD	Class 1.8. other products of Annex I of the Treaty (spices etc.)
Exmoor Blue Cheese		United Kingdom	GB	FOOD	Class 1.3. Cheeses
Fal Oyster		United Kingdom	GB	FOOD	Class 1.7. Fresh fish, molluscs, and crustaceans and products derived therefrom
Fenland Celery		United Kingdom	GB	FOOD	Class 1.6. Fruit, vegetables and cereals fresh or processed
Gloucestershire cider/perry		United Kingdom	GB	FOOD	Class 1.8. other products of Annex I of the Treaty (spices etc.)
Herefordshire cider/perry		United Kingdom	GB	FOOD	Class 1.8. other products of Annex I of the Treaty (spices etc.)
Isle of Man Manx Loaghtan Lamb		United Kingdom	GB	FOOD	Class 1.1. Fresh meat (and offal)
Isle of Man Queenies		United Kingdom	GB	FOOD	Class 1.7. Fresh fish, molluscs, and crustaceans and products derived therefrom
Jersey Royal potatoes		United Kingdom	GB	FOOD	Class 1.6. Fruit, vegetables and cereals fresh or processed
Kentish ale and Kentish strong ale		United Kingdom	GB	FOOD	Class 2.1. Beers
Lakeland Herdwick		United Kingdom	GB	FOOD	Class 1.1. Fresh meat (and offal)
London Cure Smoked Salmon		United Kingdom	GB	FOOD	Class 1.7. Fresh fish, molluscs, and crustaceans and products derived therefrom
Lough Neagh Eel		United Kingdom	GB	FOOD	Class 1.7. Fresh fish, molluscs, and crustaceans and products derived therefrom
Lough Neagh Pollan		United Kingdom	GB	FOOD	Class 1.7. Fresh fish, molluscs, and crustaceans and products derived therefrom
Melton Mowbray Pork Pie		United Kingdom	GB	FOOD	Class 1.2. Meat products (cooked, salted, smoked, etc.)
Native Shetland Wool		United Kingdom	GB	FOOD	Class 3.6. Wool
New Season Comber Potatoes / Comber Earlies		United Kingdom	GB	FOOD	Class 1.6. Fruit, vegetables and cereals fresh or processed
Newmarket Sausage		United Kingdom	GB	FOOD	Class 1.2. Meat products (cooked, salted, smoked, etc.)
Orkney beef		United Kingdom	GB	FOOD	Class 1.1. Fresh meat (and offal)
Orkney lamb		United Kingdom	GB	FOOD	Class 1.1. Fresh meat (and offal)
Orkney Scottish Island Cheddar		United Kingdom	GB	FOOD	Class 1.3. Cheeses

**Avropa İttifaqı ölkələrinin ərazilərində mühafizə olunan  
coğrafi göstəricilərin siyahısı**

**The list of geographical indications that are protected  
within the territory of the European Union countries**

**Список географических указаний, охраняемых  
на территории стран Европейского Союза**

**Bülleten № 2. 28.02.2019**

Pembrokeshire Earlies / Pembrokeshire Early Potatoes		United Kingdom	GB	FOOD	Class 1.6. Fruit, vegetables and cereals fresh or processed
Rutland Bitter		United Kingdom	GB	FOOD	Class 2.1. Beers
Scotch Beef		United Kingdom	GB	FOOD	Class 1.1. Fresh meat (and offal)
Scotch Lamb		United Kingdom	GB	FOOD	Class 1.1. Fresh meat (and offal)
Scottish Farmed Salmon		United Kingdom	GB	FOOD	Class 1.7. Fresh fish, molluscs, and crustaceans and products derived therefrom
Scottish Wild Salmon		United Kingdom	GB	FOOD	Class 1.7. Fresh fish, molluscs, and crustaceans and products derived therefrom
Shetland Lamb		United Kingdom	GB	FOOD	Class 1.1. Fresh meat (and offal)
Single Gloucester		United Kingdom	GB	FOOD	Class 1.3. Cheeses
Staffordshire Cheese		United Kingdom	GB	FOOD	Class 1.3. Cheeses
Stornoway Black Pudding		United Kingdom	GB	FOOD	Class 1.2. Meat products (cooked, salted, smoked, etc.)
Swaledale cheese		United Kingdom	GB	FOOD	Class 1.3. Cheeses
Swaledale ewes' cheese		United Kingdom	GB	FOOD	Class 1.3. Cheeses
Teviotdale Cheese		United Kingdom	GB	FOOD	Class 1.3. Cheeses
Traditional Ayrshire Dunlop		United Kingdom	GB	FOOD	Class 1.3. Cheeses
Traditional Cumberland Sausage		United Kingdom	GB	FOOD	Class 1.2. Meat products (cooked, salted, smoked, etc.)
Traditional Grimsby Smoked Fish		United Kingdom	GB	FOOD	Class 1.7. Fresh fish, molluscs, and crustaceans and products derived therefrom
Traditional Welsh Caerphilly/Traditional Welsh Caerffili		United Kingdom	GB	FOOD	Class 1.3. Cheeses
Traditional Welsh Cider		United Kingdom	GB	FOOD	Class 1.8. other products of Annex I of the Treaty (spices etc.)
Traditional Welsh Perry		United Kingdom	GB	FOOD	Class 1.8. other products of Annex I of the Treaty (spices etc.)
Vale of Evesham Asparagus		United Kingdom	GB	FOOD	Class 1.6. Fruit, vegetables and cereals fresh or processed
Welsh Beef		United Kingdom	GB	FOOD	Class 1.1. Fresh meat (and offal)
Welsh lamb		United Kingdom	GB	FOOD	Class 1.1. Fresh meat (and offal)
Welsh Laverbread		United Kingdom	GB	FOOD	Class 1.8. other products of Annex I of the Treaty (spices etc.)
West Country Beef		United Kingdom	GB	FOOD	Class 1.1. Fresh meat (and offal)
West Country farmhouse Cheddar cheese		United Kingdom	GB	FOOD	Class 1.3. Cheeses
West Country Lamb		United Kingdom	GB	FOOD	Class 1.1. Fresh meat (and offal)

**Avropa İttifaqı ölkələrinin ərazilərində mühafizə olunan  
coğrafi göstəricilərin siyahısı**

**The list of geographical indications that are protected  
within the territory of the European Union countries.**

**Список географических указаний, охраняемых  
на территории стран Европейского Союза**

**Bülleten № 2. 28.02.2019**

West Wales Coracle Caught Salmon		United Kingdom	GB	FOOD	Class 1.7. Fresh fish, molluscs, and crustaceans and products derived therefrom
West Wales Coracle Caught Sewin		United Kingdom	GB	FOOD	Class 1.7. Fresh fish, molluscs, and crustaceans and products derived therefrom
White Stilton cheese / Blue Stilton cheese		United Kingdom	GB	FOOD	Class 1.3. Cheeses
Whitstable oysters		United Kingdom	GB	FOOD	Class 1.7. Fresh fish, molluscs, and crustaceans and products derived therefrom
Worcestershire cider/perry		United Kingdom	GB	FOOD	Class 1.8. other products of Annex I of the Treaty (spices etc.)
Yorkshire Forced Rhubarb		United Kingdom	GB	FOOD	Class 1.6. Fruit, vegetables and cereals fresh or processed
Yorkshire Wensleydale		United Kingdom	GB	FOOD	Class 1.3. Cheeses
Scotch Whisky		United Kingdom	GB	SPIRITS	Whisky or Whiskey
Somerset Cider Brandy		United Kingdom	GB	SPIRITS	Cider spirit and perry spirit
Darnibole		United Kingdom	GB	WINE	
English		United Kingdom	GB	WINE	
English Regional		United Kingdom	GB	WINE	
Welsh		United Kingdom	GB	WINE	
Welsh Regional		United Kingdom	GB	WINE	

## M Ü N D Ə R İ C A T

BEYNƏLXALQ INID (WIPO ST.60) KODLARI..... 3

Sənaye nümunələrinin beynəlxalq qeydiyyatı haqqında  
Haaqa müqaviləsinə uyğun olaraq beynəlxalq reyestrə qeydiyyata  
alınmış beynəlxalq sənaye nümunələri barədə məlumatların  
dərci..... 5

Avropa İttifaqı ölkələrinin ərazilərində mühafizə olunan  
coğrafi göstəricilərin siyahısı..... 27



**Korrektorlar:**

E.Rüstəmov  
Ş.Nəbiyeva

**Operatorlar:**

İ.Qasimov  
F.Mustafayeva

---

**Tirajı:** 10 nüsxə;  
**Qiyməti:** Müqavilə ilə.

---

Azərbaycan Respublikası  
Əqli Mülkiyyət Agentliyinin  
tabeliyində olan  
Patent və Əmtəə Nişanlarının  
Ekspertizası Mərkəzi

**Ünvan:**

AZ 1078, Bakı şəh., Nəsimi rayonu,  
Mərdanov qardaşları küçəsi 124.

## QEYD ÜÇÜN

---